



EO[®] Ermeto Original *Tube clamps*



Visual index

Technical data.....S3
 Material properties.....S4
 Assembly instruction.....S5/6
 Light series (DIN 3015, part 1)S6
 Heavy series (DIN 3015, part 2).....S6
 Double series (DIN 3015, part 3).....S6
 Recommended clamp pitch.....S7
 Pipe bend assemblyS7

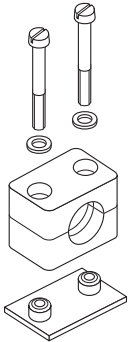
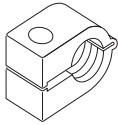
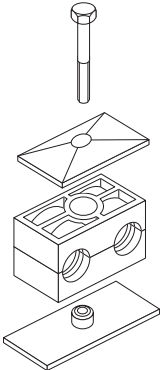
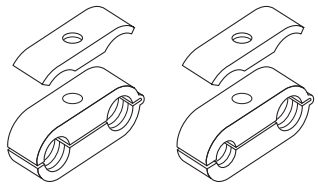
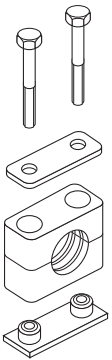
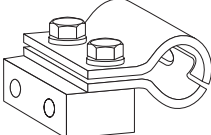
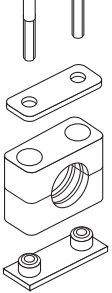
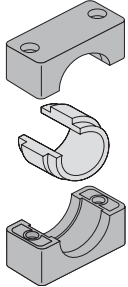
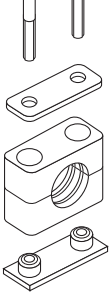
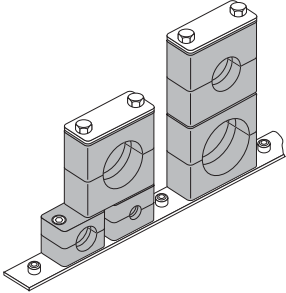
<p>Tube clamps series A</p>	 <p>p. S8–S18</p>	<p>Tube clamps series O</p>	 <p>p. S35</p>
<p>Tube clamps series B</p>	 <p>p. S19–S23</p>	<p>Double-Tube clamps series O</p>	 <p>p. S36</p>
<p>Tube clamps series C</p>	 <p>p. S24–S34</p>	<p>Hydraulic steel-clamps</p>	 <p>p. S37</p>
<p>Tube clamps series 2+5</p>	 <p>p. S24–S34</p>	<p>Tube clamps with Elastomer Inlay</p>	 <p>p. S39</p>
<p>Tube clamps series 2+5</p>	 <p>p. S24–S34</p>	<p>Tube clamps-series 2+5</p>	 <p>p. S40</p>

Tube clamps

DIN 3015

Programme:

Tube clamps series A (according to DIN 3015 Part 1)

Available in seven standard sizes for normal mechanical requirements.

- Outer tube diameter for the metric series 6 to 57 mm
- Outer tube diameter for the inch-size series R 1/8" to R 1 1/2"
- Outer tube diameter for the imperial size series 1/4" to 2 1/2"

The clamp body is available in a round/closed version.

Welding plates, rail-supports, cover plates and construction types.

Tube clamps series B (according to DIN 3015 Part 3)

Available as a twin tube clamp in five standard sizes for normal mechanical requirements.

Outer tube diameter 6 to 42 mm.

The clamp body is available in a square/open design.

Welding plates, rail-supports, cover plates and construction types.

Clamp halves with different diameters are only possible when used together.

Tube clamps series C (according to DIN 3015 Part 2)

Specially designed for high mechanical requirements, and available in eight standard sizes.

- Outer tube diameter 6 to 220 mm.

The clamp body is available in a square/closed design.

Welding plates, rail-supports, cover plates and construction types.

Design:

According to DIN 3015:

Both upper and lower clamp-halves are identical.

Webs inside the bore of the clamps provide an impact and vibration deadening effect, and absorb the forces towards the direction of the tube axis.

When using hoses and cables, we recommend the use of clamp halves with a smooth bore.

Clamp material:

Polypropylene	–30°C up to + 90° C	colour dark green
Polyamide	–40°C up to + 120° C	colour black
Rubber	–50°C up to + 120° C	colour black
Aluminium	up to + 300° C	

All metal parts available also in stainless steel.

Other materials upon request.

Stainless steel qualities

Stainless steel 1.4401/1.4571 (AISI 316/316 TI), resistant against rust and acid.

Accessories material:

Steel. Screws as well as cover plates of series A and B are galvanized.

Rail-supports are also available with zinc plated surface.

Resistance to stress:

The remarkable features of **Tube Clamps** are their considerable re-set capability, high tensile strength, as well as their very high output strength and excellent resistance to cold. The choice of design and clamp material depends on the specific demands of the mechanical and thermal requirements.

Order code:

The order code for clamp halves as well as the reference No. for complete tube clamps incorporates the serial indication, material description and interior surface.

Example of description:

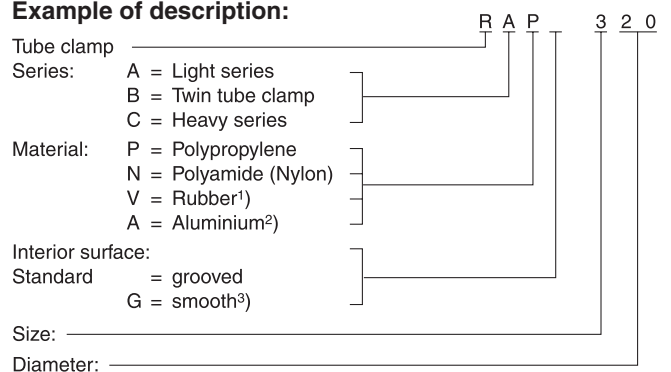

¹⁾ Rubber only available for series A and B, inside smooth and series C grooved design

²⁾ Aluminium only available for series A size 1 to 6 and series C size 1 to 8

³⁾ Smooth interior surface in series C only to size 4
Aluminium clamps only available in a grooved design
Inside smooth series A only size 1 to 6

Registration:

On request

Tube clamps material properties

DIN 3015

Mechanical properties		Polypropylene (PP)	Polyamide 6 (PA 6)	Aluminium	Rubber
Density		0.906 g/cm ³	1.12–1.15g/cm ³	2.65 g/cm ³	0.98 g/cm ³
Flexural deflection	DIN 53452	36 N/mm ²	130...200 N/mm ²	70 N/mm ²	–
Impact resistance	DIN 53453	no break	no break	–	
Compressive strength	DIN 53454	90 N/mm ²	120 N/mm ²	HB 500...600 N/mm ²	A and B: 64° shore C: 73° shore
Modulus of elasticity	DIN 53452	1500 N/mm ²	3000 N/mm ²	70.000 N/mm ²	
Tensile strength					A and B: 6.1 N/mm ² C: 8.5 N/mm ²
without breakage	DIN 53454	25–35 N/mm ²	80–90 N/mm ²	180 N/mm ²	

Thermal properties					
Temp. resistance		–30 ... + 90°C	–40 ... + 120°C	300°C	–50 ... +120°C

Chemical properties					
Weak acids		limited resistant	limited resistant		resistant
Weak alkalis		limited resistant	limited resistant		resistant
Alcohol		resistant	resistant		resistant
Petrol		limited resistant	resistant		limited resistant
Mineral oils		resistant	resistant		resistant
Other oils		resistant	resistant		resistant

The outlined particulars are approximate values and are only shown for reference, which are not binding, and with regard to possible protection of third parties. They do not exempt you from your own examination of suitability of the products delivered by us. Therefore, these values can only be used in a limited way for guidance only.

The application of the products is carried out outside of our control and, therefore, is exclusively subject to your own area of responsibility. Any claim however would be limited for all damages to the value of the goods supplied by us and in use by you.

It goes without saying, that we guarantee the perfect quality of our products according to our general sales and delivery conditions.

Tube clamps assembly instruction

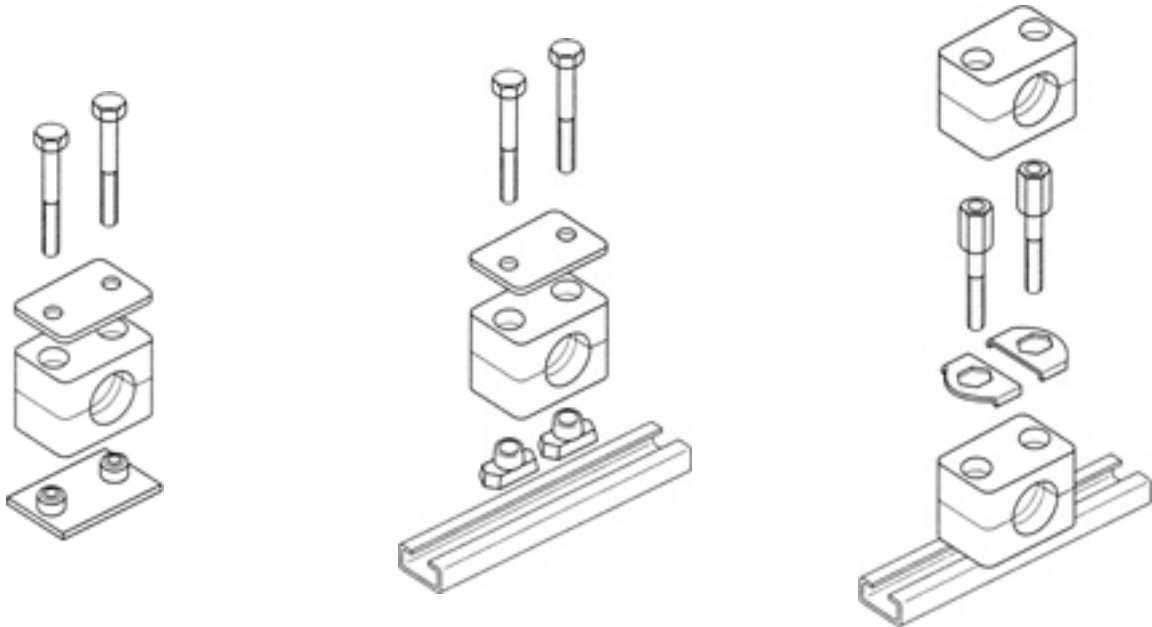

Assembly:

Assembly on to metal welding plates

Place welding plates on a base appropriate for the load. Make sure that the clamps are properly aligned. Clamp lower clamp half onto welding plate, insert tube, place upper clamp half onto lower half and fasten with the screws. Attention must be paid to the bias (after completed assembly, clamp halves may not be in contact)! Do not weld with fitted plastic clamp! Extended welding plates may be screw-fastened to the base.

Assembly on support rails

Support rails are available in four different heights and come in pieces of 1 m or 2 m length, as required. Weld on support rail or screw-fasten with fastening angle bracket. Insert support rail nuts in rail and turn until stoppage. For heavy duty construction series, nuts are simply pushed in. Clamp lower clamp half on support rail nuts, insert tube, place upper clamp half onto lower half and fasten with the screws. Before fastening the screws the clamp may still be positioned. Attention must be paid to the bias (after completed assembly, the clamp halves may not be in contact)!

Construction assembly

Clamps allow the assembly of multiple clamps of the same construction size and of different tube diameters one above the other. The construction assembly is carried out with special fixing screws that are secured against twisting by applying a locking plate. Clamp lower clamp half on welding plate or support rail respectively, insert tube, place upper clamp half on lower half and fasten with fixing screws. The fixing screw juts out from the upper clamp half. The application of a locking late scurely fastens the fixing screw and prevents twisting. Clamp on second clamp half on to the fixing screws etc.



Tube clamps

DIN 3015

Screw tightening torque and axial pipe shearing forces

The indicated screw tightening torque and axial pipe shearing forces refer to the assembly with cover plates and outside hexagon bolts according to DIN 931/933. The axial pipe shearing force (according to DIN 3015, part 10) is an average value, determined by three tests made with a steel pipe according to DIN 2448 of St. 37, for which static friction is assumed (temperature during tests: 23°C). When loading the clamp with the indicated test force (F) in axial pipe direction, the pipe must not slide in the clamp.

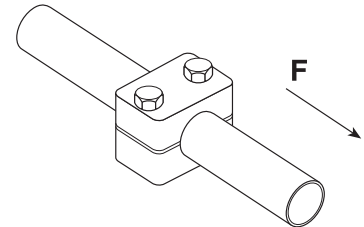

Light series (DIN 3015, part 1)

Size	Fixing screw DIN 931/933	Polypropylene		Polyamide		Aluminium	
		Screw tightening torque (Mn)	Pipe shearing force F (kN)	Screw tightening torque (Mn)	Pipe shearing force F (kN)	Screw tightening torque (Mn)	Pipe shearing force F (kN)
0	M6	8	0.6	10	0.6	–	–
1	M6	8	1.1	10	0.7	12	4.2
2	M6	8	1.2	10	0.8	12	4.3
3	M6	8	1.4	10	1.6	12	4.8
4	M6	8	1.5	10	1.7	12	5.0
5	M6	8	1.9	10	2.0	12	7.3
6	M6	8	2.0	10	2.5	12	8.9

Heavy series (DIN 3015, part 2)

Size	Fixing screw DIN 931/933	Polypropylene		Polyamide		Aluminium	
		Screw tightening torque (Mn)	Pipe shearing force F (kN)	Screw tightening torque (Mn)	Pipe shearing force F (kN)	Screw tightening torque (Mn)	Pipe shearing force F (kN)
1	M10	12	1.6	20	4.2	30	12.1
2	M10	12	2.9	20	4.5	30	15.1
3	M10	15	3.3	25	5.1	35	15.5
4	M12	30	8.2	40	9.3	55	29.4
5	M16	45	11.0	55	15.8	120	34.8
6	M20	80	14.0	150	21.0	220	50.0
7	M24	110	28.0	200	32.0	250	70.6
8	M30	180	40.0	350	48.0	500	84.5

Double series (DIN 3015, part 3)

Size	Fixing screw DIN 931/933	Polypropylene		Polyamide	
		Screw tightening torque (Mn)	Pipe shearing force F (kN)	Screw tightening torque (Mn)	Pipe shearing force F (kN)
1	M6	5	0.9	5	0.9
2	M8	12	2.1	12	2.2
3	M8	12	1.9	12	2.0
4	M8	12	2.7	12	2.9
5	M8	8	1.7	8	2.5

Tube clamps

DIN 3015

Recommended clamp pitch

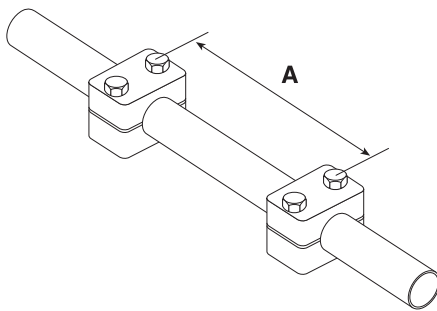

Pipe bend assembly

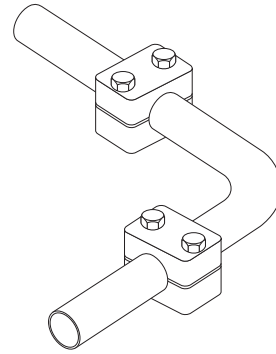

The clamp pitches corresponding to respective outside pipe diameters are standard for static loads.

Pipe bends must be fixed with pipe clamps immediately in front of and behind the bend.

Outside pipe diameter (mm)	Clamp pitch A (m)
6.0– 12.7	1.0
12.7– 22.0	1.2
22.0– 32.0	1.5
32.0– 38.0	2.0
38.0– 57.0	2.7
57.0– 75.0	3.0
75.0– 76.1	3.5
76.1– 88.9	3.7
88.9–102.0	4.0
102.0–114.0	4.5
114.0–168.0	5.0
168.0–219.0	6.0



Tube clamps series A (Light construction series) – Components

DIN 3015, part 1

Order code for clamp halves:

- Polypropylene – **RAP**
- Inside smooth – **RAPG**
- Polyamide 6 – **RAN**
- Inside smooth – **RANG**
- Rubber – **RAVG**
- Aluminium – **RAA¹⁾**

(Please exchange as required standard abbreviation RAP in column for “clamp halves”)

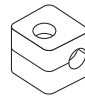

size 0

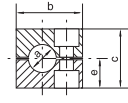

size 0

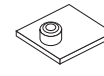

size 0

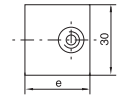

size 0

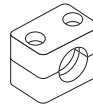

size 1-6

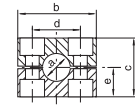

size 1-6
Width: 30 mm

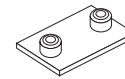

size 1-6

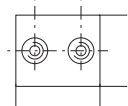

size 1-6
Thickness:
3 mm

clamp size	Tube O.D. mm a	Tube NB	Tube O.D.	1 part		welding plate, short					
				RAP... Order code	2 clamp halves dimensions: b c d e	APK A... Order code	dimensions: d e				
0	6.0	G 1/8	1/4	RAP006X RAP006.4X RAP008X RAP009.5X RAP010X RAP012X	28	27	-	13.5	APKA0X	-	30
	6.4										
	8.0										
	9.5										
	10.0										
12.0											
1	6.0	G 1/8	1/4	RAP106X RAP106.4X RAP108X RAP109.5X RAP110X RAP112X	34	27	20	13.5	APKA1X	20	36
	6.4										
	8.0										
	9.5										
	10.0										
12.0											
2	12.7	G 1/4	1/2	RAP212.7X RAP213.5X RAP214X RAP215X RAP216X RAP217.2X RAP218X	40	33	26	16.5	APKA2X	26	42
	13.5										
	14.0										
	15.0	G 3/8	5/8								
	16.0										
17.2											
18.0											
3	19.0	G 1/2	3/4	RAP319X RAP320X RAP321.3X RAP322X RAP323X RAP325X	48	35	33	17.5	APKA3X	33	50
	20.0										
	21.3										
	22.0										
	23.0										
25.0	1										
4	26.9	G 3/4		RAP426.9X RAP428X RAP430X	57	42	40	21	APKA4X	40	59
	28.0										
	30.0										
5	32.0	G 1	1 1/4	RAP532X RAP533.7X RAP535X RAP538X RAP540X RAP542X	70	58	52	29	APKA5X	52	72
	33.7										
	35.0										
	38.0	G 1 1/4	1 1/2								
	40.0										
42.0											
6	44.5	G 1 1/2	1 3/4	RAP644.5X RAP645X RAP648X RAP650X RAP650.8X RAP652X RAP655X RAP657X	86	66	66	33	APKA6X	66	88
	45.0										
	48.0										
	50.0										
	50.8										
	52.0										
	55.0										
57.0	2 1/4										

Continuation see next page ...

Tube clamps series A (Light construction series) – Components (Continued)

DIN 3015, part 1

Order code for clamp halves:

- Polypropylene – **RAP**
- Inside smooth – **RAPG**
- Polyamide 6 – **RAN**
- Inside smooth – **RANG**
- Rubber – **RAVG**
- Aluminium – **RAA¹⁾**

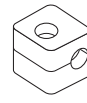
 (Please exchange as required standard abbreviation
 RAP in column for "clamp halves")

size 0

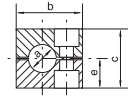

size 0

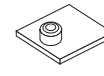

size 0

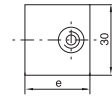

size 0

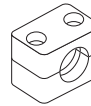

size 1-6

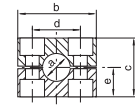
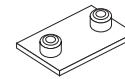
 size 1-6
 Width: 30 mm

size 1-6

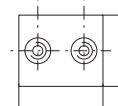
 size 1-6
 Thickness:
 3 mm

clamp size	Tube O.D. mm a	Tube NB	Tube O.D.	1 part		welding plate, short	
				RAP... Order code	dimensions: b c d e	APK A... Order code	dimensions: d e
7	57.2	G 2	2 1/4	RAP757.2X RAP-760.3X RAP-763.50X RAP-770X RAP-773X RAP-776,1X	121 93.6 94 46.8	APKA7X	94 122
	60.3		2 1/2				
	63,5		2 3/4				
	70.0						
	73.0						
	76.1	G 2 1/2	3				
8	88.9	G 3	4	RAP-888.9X RAP-8101.8X	147 117.6 120 58.8	APKA8X	120 148
	101.8						

When assembling solid rubber clamps, covering plates, hexagon screws and locking washers must be used. All metal parts available in stainless steel.

1) Aluminium only sizes 1 to 6.



Tube clamps series A (Light construction series) – Components

DIN 3015, part 1

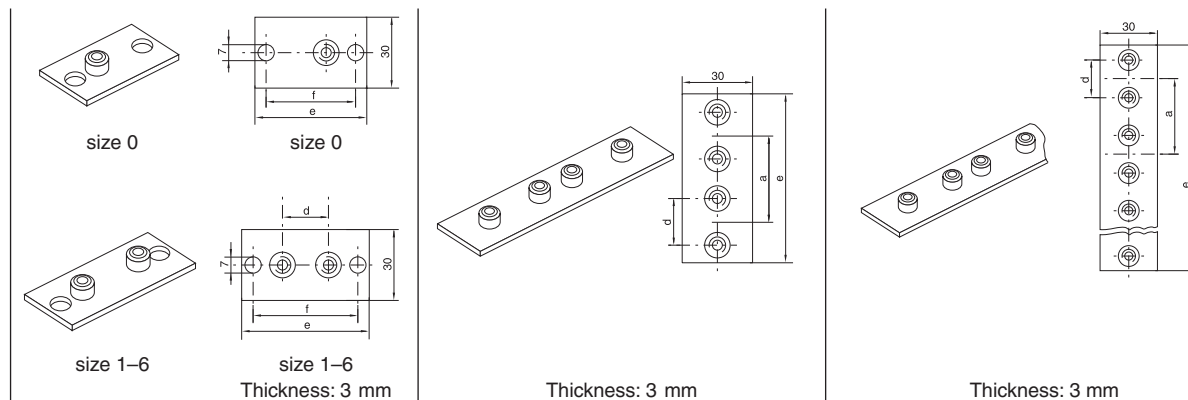

clamp size	weld/screw plate, long			twin welding plate			multiple weld plate					
	APL A... Order code	dimensions:			APD A... Order code	dimensions:			APR A... Order code	dimensions:		
		d	e	f		d	a	e		d	a	e
0	APLA0X	–	58	44	APDA0X	–	30	61	APRA0X (10 clamps)	–	30	298
1	APLA1X	20	64	50	APDA1X	20	35	69	APRA1X (10 clamps)	20	35	349
2	APLA2X	26	70	56	APDA2X	26	43	86	APRA2X (10 clamps)	26	43	427
3	APLA3X	33	78	64	APDA3X	33	52	104	APRA3X (10 clamps)	33	52	516
4	APLA4X	40	87	73	APDA4X	40	60	117	APRA4X (5 clamps)	40	60	297
5	APLA5X	52	100	86	APDA5X	52	75	145	APRA5X (5 clamps)	52	75	370
6	APLA6X	66	116	100	APDA6X	66	90	176	APRA6X (5 clamps)	66	90	446
7	APLA7X	94	150	136								
8	APLA8X	120	178	162								

Metal parts also available in stainless steel.

Tube clamps series A (Light construction series) – Components

DIN 3015, part 1

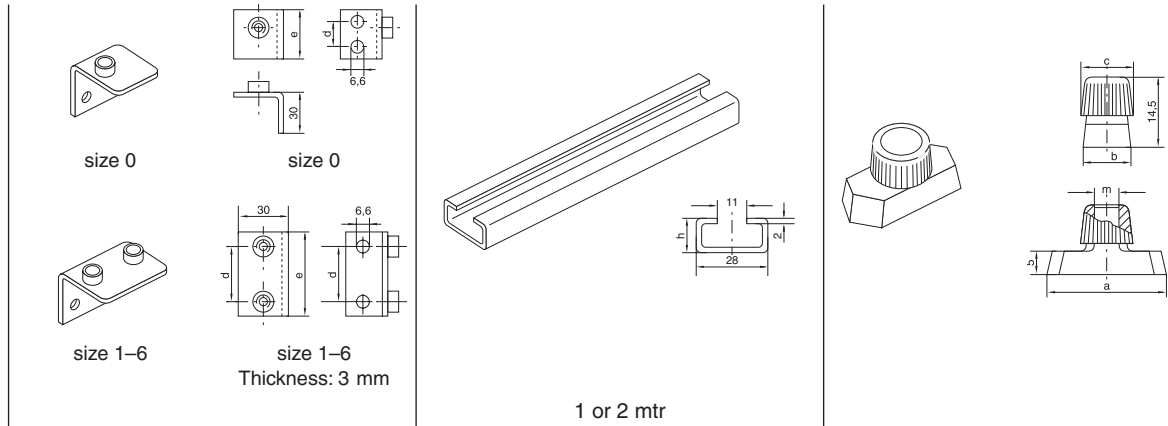

clamp size	weld plate, angled		mounting rail		rail nut				
	APW A... Order code	dimensions: d e	TS...A/B Order code	dimensions: h	TM...A/B1 Order code	dimensions: a b c m			
0	APWA0X	14 30	TS11A/B1X TS11A/B2X TS14A/B1X TS14A/B2X TS30A/B1X TS30A/B2X	TS11: 11 TS14: 14 TS30: 30	TMA/TMB1VERZX	25.4	10.4	12	M6
1	APWA1X	20 36							
2	APWA2X	26 42							
3	APWA3X	33 50							
4	APWA4X	40 59							
5	APWA5X	52 72							
6	APWA6X	66 88							

Metal parts also available in stainless steel.



Tube clamps series A (Light construction series) – Components

DIN 3015, part 1

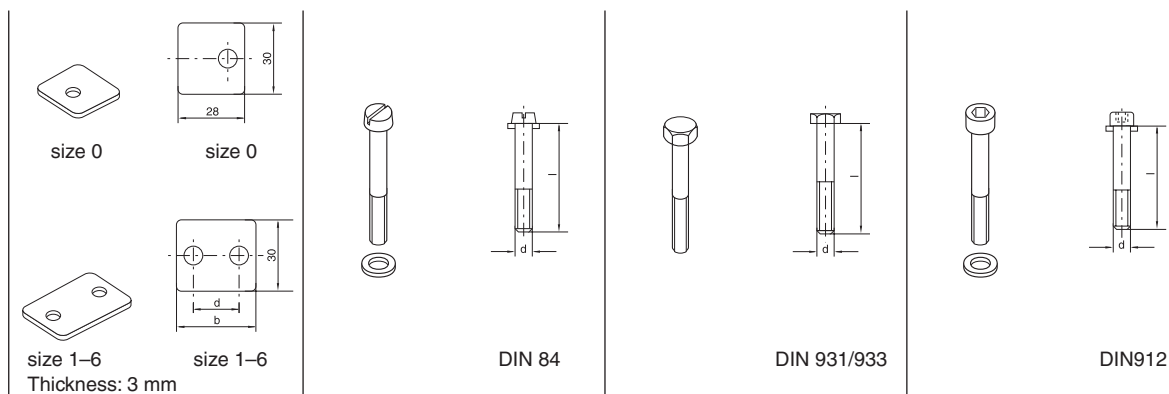

clamp size	cover plate		slot head		hexagon head		socket head	
	DP A... Order code	dimensions: b d	SL A... Order code	dimensions: d x L	SSL A... Order code	dimensions: d x L	IS A... Order code	dimensions: d x L
0	DPA0X	– –	SLA0X	M 06x20	SSLA0X	M 06x30	ISA0X	M 06x20
1	DPA1X	34 20	SLA1X	M 06x20	SSLA0X	M 06x30	ISA0X	M 06x20
2	DPA2X	40 26	SLA2X	M 06x25	SSLA2/SSB1X	M 06x35	ISA2X	M 06x25
3	DPA3X	48 33	SLA3X	M 06x30	SSLA3X	M 06x40	ISA3X	M 06x30
4	DPA4X	57 40	SLA4X	M 06x35	SSLA4X	M 06x45	ISA4X	M 06x35
5	DPA5X	70 52	SLA5X	M 06x50	SSLA5X	M 06x60	ISA5X	M 06x50
6	DPA6X	86 66	SLA6X	M 06x60	SSLA6X	M 06x70	ISA6X	M 06x60
7	DPA7X	120 94			SSLA7X	M 06x100		
8	DPA8X	146 120			SSLA8X	M 06x125		

All metal parts available in stainless steel.

Tube clamps series A (Light construction series) – Components

DIN 3015, part 1

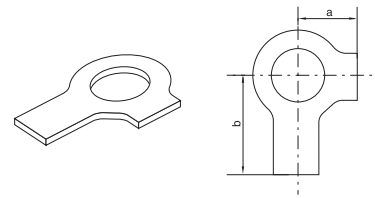
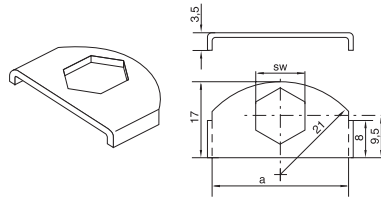
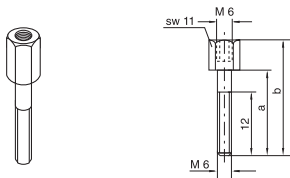

clamp size	stacking ¹⁾		locking plate ¹⁾		locking washer ²⁾	
	AS A... Order code	dimensions: a b	SB A Order code	dimensions: a SW	US A Order code	dimensions: a b
0	ASA0X (ASB1X)	20 34	SBAX	30 11	USA/USB1X	9 18
1	ASA0X (ASB1X)	20 34				
2	ASA2X	25 39				
3	ASA3X	30 44				
4	ASA4X	35 49				
5	ASA5X	50 64				
6	ASA6X	60 74				

¹⁾ The use of stacking bolts necessitates the use of locking plates in the construction assembly.

²⁾ When assembling solid rubber clamps, cover plates, hexagon screws and locking washers must be used. Metal parts also available in stainless steel.



Tube clamps series A (Light construction series) – Complete range

Polypropylene – **RAP**
 Inside smooth – **RAPG**
 Polyamide 6 – **RAN**
 Inside smooth – **RANG**
 Rubber – **RAVG***
 Aluminium – **RAA**

(As required please exchange standard abbreviation RAP in column for “Order code”)

2 clamp halves, weld plate **short**, slot head bolts and bushes

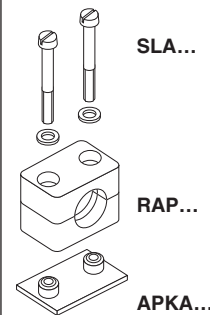

2 clamp halves, weld plate **short**, socket head bolts and bushes

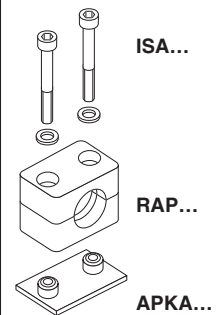

2 clamp halves, weld plate **short**, cover plate hex. head bolts

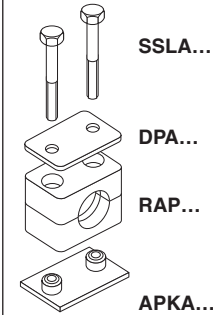

clamp size	Tube O.D. mm	Tube NB	Tube O.D.	Order code	Order code	Order code	
0 ¹⁾	6.0	G 1/8	1/4	RAP1-006	RAP2-006	RAP3-006	
	6.4			RAP1-006.4	RAP2-006.4	RAP3-006.4	
	8.0			RAP1-008	RAP2-008	RAP3-008	
	9.5		3/8	RAP1-009.5	RAP2-009.5	RAP3-009.5	
	10.0			RAP1-010	RAP2-010	RAP3-010	
	12.0			RAP1-012	RAP2-012	RAP3-012	
1	6.0	G 1/8	1/4	RAP1-106	RAP2-106	RAP3-106	
	6.4			RAP1-106.4	RAP2-106.4	RAP3-106.4	
	8.0			RAP1-108	RAP2-108	RAP3-108	
	9.5		3/8	RAP1-109.5	RAP2-109.5	RAP3-109.5	
	10.0			RAP1-110	RAP2-110	RAP3-110	
	12.0			RAP1-112	RAP2-112	RAP3-112	
2	12.7	G 1/4	1/2	RAP1-212.7	RAP2-212.7	RAP3-212.7	
	13.5			RAP1-213.5	RAP2-213.5	RAP3-213.5	
	14.0			RAP1-214	RAP2-214	RAP3-214	
	15.0			RAP1-215	RAP2-215	RAP3-215	
	16.0	G 3/8	5/8	RAP1-216	RAP2-216	RAP3-216	
	17.2			RAP1-217.2	RAP2-217.2	RAP3-217.2	
	18.0			RAP1-218	RAP2-218	RAP3-218	
3	19.0	G 1/2	3/4	RAP1-319	RAP2-319	RAP3-319	
	20.0			RAP1-320	RAP2-320	RAP3-320	
	21.3			RAP1-321.3	RAP2-321.3	RAP3-321.3	
	22.0		1	RAP1-322	RAP2-322	RAP3-322	
	23.0			RAP1-323	RAP2-323	RAP3-323	
	25.0			RAP1-325	RAP2-325	RAP3-325	
4	26.9	G 3/4		RAP1-426.9	RAP2-426.9	RAP3-426.9	
	28.0			RAP1-428	RAP2-428	RAP3-428	
	30.0			RAP1-430	RAP2-430	RAP3-430	
5	32.0	G 1	1 1/4	RAP1-532	RAP2-532	RAP3-532	
	33.7			RAP1-533.7	RAP2-533.7	RAP3-533.7	
	35.0			RAP1-535	RAP2-535	RAP3-535	
	38.0	G 1 1/4	1 1/2	RAP1-538	RAP2-538	RAP3-538	
	40.0			RAP1-540	RAP2-540	RAP3-540	
	42.0			RAP1-542	RAP2-542	RAP3-542	
6	44.5	G 1 1/2	1 3/4	RAP1-644.5	RAP2-644.5	RAP3-644.5	
	45.0			RAP1-645	RAP2-645	RAP3-645	
	48.0			RAP1-648	RAP2-648	RAP3-648	
	50.0	2		RAP1-650	RAP2-650	RAP3-650	
	50.8			RAP1-650.8	RAP2-650.8	RAP3-650.8	
	52.0			RAP1-652	RAP2-652	RAP3-652	
	55.0			RAP1-655	RAP2-655	RAP3-655	
	57.0			2 1/4	RAP1-657	RAP2-657	RAP3-657

Delivery in unassembled individual components.

¹⁾ Contrary to the illustration size 0 clamps are secured by only one screw.

* Only with cover plate, hexagon screws and locking washers.

Tube clamps series A (Light construction series) – Complete range

Polypropylene – **RAP**
 Inside smooth – **RAPG**
 Polyamide 6 – **RAN**
 Inside smooth – **RANG**
 Rubber – **RAVG***
 Aluminium – **RAA**

(As required please exchange standard abbreviation RAP in column for "Order code")

2 clamp halves, weld/
screw plate, slot head
bolts and bushes

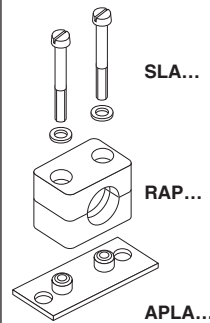

2 clamp halves, weld/
screw plate, socket
head bolts and bushes

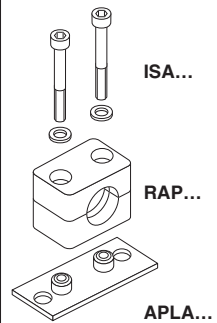

2 clamp halves, weld/
screw plate, cover plate
and hex. head bolts

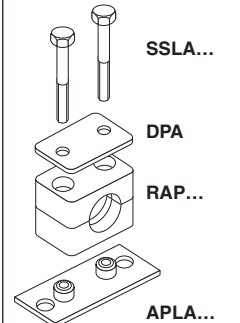

clamp size	Tube O.D. mm	Tube NB	Tube O.D.	Order code	Order code	Order code	
0 ¹⁾	6.0	G 1/8	1/4	RAP4-006	RAP5-006	RAP6-006	
	6.4			RAP4-006.4	RAP5-006.4	RAP6-006.4	
	8.0			RAP4-008	RAP5-008	RAP6-008	
	9.5		5/8	RAP4-009.5	RAP5-009.5	RAP6-009.5	
	10.0			RAP4-010	RAP5-010	RAP6-010	
	12.0			RAP4-012	RAP5-012	RAP6-012	
1	6.0	G 1/8	1/4	RAP4-106	RAP5-106	RAP6-106	
	6.4			RAP4-106.4	RAP5-106.4	RAP6-106.4	
	8.0			RAP4-108	RAP5-108	RAP6-108	
	9.5		5/8	RAP4-109.5	RAP5-109.5	RAP6-109.5	
	10.0			RAP4-110	RAP5-110	RAP6-110	
	12.0			RAP4-112	RAP5-112	RAP6-112	
2	12.7	G 1/4	1/2	RAP4-212.7	RAP5-212.7	RAP6-212.7	
	13.5			RAP4-213.5	RAP5-213.5	RAP6-213.5	
	14.0			RAP4-214	RAP5-214	RAP6-214	
	15.0			RAP4-215	RAP5-215	RAP6-215	
	16.0	G 3/8	5/8	RAP4-216	RAP5-216	RAP6-216	
	17.2			RAP4-217.2	RAP5-217.2	RAP6-217.2	
	18.0			RAP4-218	RAP5-218	RAP6-218	
3	19.0	G 1/2	3/4	RAP4-319	RAP5-319	RAP6-319	
	20.0			RAP4-320	RAP5-320	RAP6-320	
	21.3			RAP4-321.3	RAP5-321.3	RAP6-321.3	
	22.0		1	RAP4-322	RAP5-322	RAP6-322	
	23.0			RAP4-323	RAP5-323	RAP6-323	
	25.0			RAP4-325	RAP5-325	RAP6-325	
4	26.9	G 3/4		RAP4-426.9	RAP5-426.9	RAP6-426.9	
	28.0			RAP4-428	RAP5-428	RAP6-428	
	30.0			RAP4-430	RAP5-430	RAP6-430	
5	32.0	G 1	1 1/4	RAP4-532	RAP5-532	RAP6-532	
	33.7			RAP4-533.7	RAP5-533.7	RAP6-533.7	
	35.0			RAP4-535	RAP5-535	RAP6-535	
	38.0	G 1 1/4	1 1/2	RAP4-538	RAP5-538	RAP6-538	
	40.0			RAP4-540	RAP5-540	RAP6-540	
	42.0			RAP4-542	RAP5-542	RAP6-542	
6	44.5	G 1 1/2	1 3/4	RAP4-644.5	RAP5-644.5	RAP6-644.5	
	45.0			RAP4-645	RAP5-645	RAP6-645	
	48.0			RAP4-648	RAP5-648	RAP6-648	
	50.0	2		RAP4-650	RAP5-650	RAP6-650	
	50.8			RAP4-650.8	RAP5-650.8	RAP6-650.8	
	52.0			RAP4-652	RAP5-652	RAP6-652	
	55.0			RAP4-655	RAP5-655	RAP6-655	
	57.0			2 1/4	RAP4-657	RAP5-657	RAP6-657

Delivery in unassembled individual components.

¹⁾ Contrary to the illustration size 0 clamps are secured by only one screw.

* Only with cover plate, hexagon screws and locking washers.

Tube clamps series A (Light construction series) – Complete range

Polypropylene – **RAP**
 Inside smooth – **RAPG**
 Polyamide 6 – **RAN**
 Inside smooth – **RANG**
 Rubber – **RAVG***
 Aluminium – **RAA**

(As required please exchange standard abbreviation RAP in column for “Order code”)

2 clamp halves, rail nuts, slot head bolts and bushes

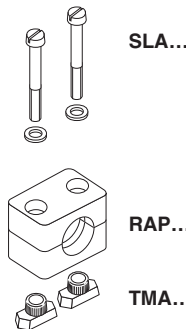

2 clamp halves, rail nuts, socket head bolts and bushes

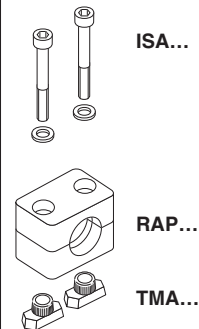

2 clamp halves, rail nuts, cover plate and hex. head bolts

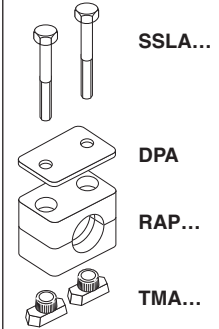

clamp size	Tube O.D. mm	Tube NB	Tube O.D.	Order code	Order code	Order code	
0 ¹⁾	6.0	G 1/8	1/4	RAP9-006	RAP10-006	RAP12-006	
	6.4			RAP9-006.4	RAP10-006.4	RAP12-006.4	
	8.0			RAP9-008	RAP10-008	RAP12-008	
	9.5			RAP9-009.5	RAP10-009.5	RAP12-009.5	
	10.0			RAP9-010	RAP10-010	RAP12-010	
	12.0			RAP9-012	RAP10-012	RAP12-012	
1	6.0	G 1/8	1/4	RAP9-106	RAP10-106	RAP12-106	
	6.4			RAP9-106.4	RAP10-106.4	RAP12-106.4	
	8.0			RAP9-108	RAP10-108	RAP12-108	
	9.5			RAP9-109.5	RAP10-109.5	RAP12-109.5	
	10.0			RAP9-110	RAP10-110	RAP12-110	
	12.0			RAP9-112	RAP10-112	RAP12-112	
2	12.7	G 1/4	1/2	RAP9-212.7	RAP10-212.7	RAP12-212.7	
	13.5			RAP9-213.5	RAP10-213.5	RAP12-213.5	
	14.0			RAP9-214	RAP10-214	RAP12-214	
	15.0	G 3/8	5/8	RAP9-215	RAP10-215	RAP12-215	
	16.0			RAP9-216	RAP10-216	RAP12-216	
	17.2			RAP9-217.2	RAP10-217.2	RAP12-217.2	
18.0	RAP9-218	RAP10-218	RAP12-218				
3	19.0	G 1/2	3/4	RAP9-319	RAP10-319	RAP12-319	
	20.0			RAP9-320	RAP10-320	RAP12-320	
	21.3			RAP9-321.3	RAP10-321.3	RAP12-321.3	
	22.0		1	RAP9-322	RAP10-322	RAP12-322	
	23.0			RAP9-323	RAP10-323	RAP12-323	
	25.0			RAP9-325	RAP10-325	RAP12-325	
4	26.9	G 3/4		RAP9-426.9	RAP10-426.9	RAP12-426.9	
	28.0			RAP9-428	RAP10-428	RAP12-428	
	30.0			RAP9-430	RAP10-430	RAP12-430	
5	32.0	G 1	1 1/4	RAP9-532	RAP10-532	RAP12-532	
	33.7			RAP9-533.7	RAP10-533.7	RAP12-533.7	
	35.0			RAP9-535	RAP10-535	RAP12-535	
	38.0	G 1 1/4	1 1/2	RAP9-538	RAP10-538	RAP12-538	
	40.0			RAP9-540	RAP10-540	RAP12-540	
	42.0			RAP9-542	RAP10-542	RAP12-542	
6	44.5	G 1 1/2	1 3/4	RAP9-644.5	RAP10-644.5	RAP12-644.5	
	45.0			RAP9-645	RAP10-645	RAP12-645	
	48.0			RAP9-648	RAP10-648	RAP12-648	
	50.0	2	2	RAP9-650	RAP10-650	RAP12-650	
	50.8			RAP9-650.8	RAP10-650.8	RAP12-650.8	
	52.0			RAP9-652	RAP10-652	RAP12-652	
	55.0			RAP9-655	RAP10-655	RAP12-655	
	57.0			2 1/4	RAP9-657	RAP10-657	RAP12-657

Delivery in unassembled individual components.

¹⁾ Contrary to the illustration size 0 clamps are secured by only one screw.

* Only with cover plate, hexagon screws and locking washers.

Tube clamps series A – Complete range

Polypropylene – **RAP**
 Inside smooth – **RAPG**
 Polyamide 6 – **RAN**
 Inside smooth – **RANG**
 Rubber – **RAVG***
 Aluminium – **RAA**

(As required please exchange standard abbreviation RAP in column for "Order code")

2 clamp halves, slot heads and bushes

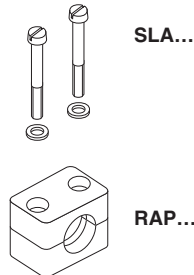

2 clamp halves, socket head bolts and bushes

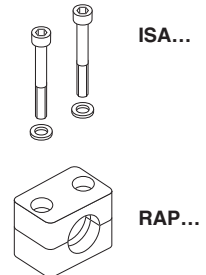

clamp size	Tube O.D. mm	Tube NB	Tube O.D.	Order code	Order code
0 ¹⁾	6.0	G 1/8	1/4	RAP13-006	RAP14-006
	6.4			RAP13-006.4	RAP14-006.4
	8.0			RAP13-008	RAP14-008
	9.5			RAP13-009.5	RAP14-009.5
	10.0			RAP13-010	RAP14-010
	12.0			RAP13-012	RAP14-012
1	6.0	G 1/8	1/4	RAP13-106	RAP14-106
	6.4			RAP13-106.4	RAP14-106.4
	8.0			RAP13-108	RAP14-108
	9.5			RAP13-109.5	RAP14-109.5
	10.0			RAP13-110	RAP14-110
	12.0			RAP13-112	RAP14-112
2	12.7	G 1/4	1/2	RAP13-212.7	RAP14-212.7
	13.5			RAP13-213.5	RAP14-213.5
	14.0			RAP13-214	RAP14-214
	15.0	G 3/8	5/8	RAP13-215	RAP14-215
	16.0			RAP13-216	RAP14-216
	17.2			RAP13-217.2	RAP14-217.2
18.0	RAP13-218	RAP14-218			
3	19.0	G 1/2	3/4	RAP13-319	RAP14-319
	20.0			RAP13-320	RAP14-320
	21.3			RAP13-321.3	RAP14-321.3
	22.0	1	1	RAP13-322	RAP14-322
	23.0			RAP13-323	RAP14-323
	25.0			RAP13-325	RAP14-325
4	26.9	G 3/4		RAP13-426.9	RAP14-426.9
	28.0			RAP13-428	RAP14-428
	30.0			RAP13-430	RAP14-430
5	32.0	G 1	1 1/4	RAP13-532	RAP14-532
	33.7			RAP13-533.7	RAP14-533.7
	35.0			RAP13-535	RAP14-535
	38.0	G 1 1/4	1 1/2	RAP13-538	RAP14-538
	40.0			RAP13-540	RAP14-540
	42.0			RAP13-542	RAP14-542
6	44.5	G 1 1/2	1 3/4	RAP13-644.5	RAP14-644.5
	45.0			RAP13-645	RAP14-645
	48.0			RAP13-648	RAP14-648
	50.0			RAP13-650	RAP14-650
	50.8	2	2	RAP13-650.8	RAP14-650.8
	52.0			RAP13-652	RAP14-652
	55.0			RAP13-655	RAP14-655
	57.0			RAP13-657	RAP14-657
			2 1/4		

Delivery in unassembled individual components.

¹⁾ Contrary to the illustration size 0 clamps are secured by only one screw.

* Only with cover plate, hexagon screws and locking washers.

Tube clamps series A – Complete range

Polypropylene – **RAP**
 Inside smooth – **RAPG**
 Polyamide 6 – **RAN**
 Inside smooth – **RANG**
 Rubber – **RAVG***
 Aluminium – **RAA**

(As required please exchange standard abbreviation RAP in column for “Order code”)

2 clamp halves, cover plate and hex. head bolts

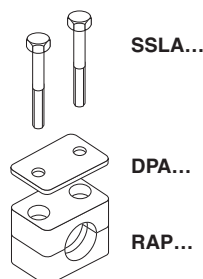

2 clamp halves, stacking bolts and locking plate

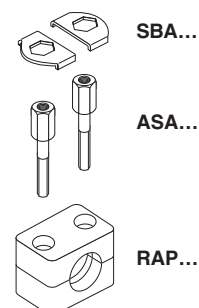

clamp size	Tube O.D. mm	Tube NB	Tube O.D.	Order code	Order code
0 ¹⁾	6.0	G 1/8	1/4	RAP16-006	RAP18-006
	6.4			RAP16-006.4	RAP18-006.4
	8.0			RAP16-008	RAP18-008
	9.5			RAP16-009.5	RAP18-009.5
	10.0			RAP16-010	RAP18-010
	12.0			RAP16-012	RAP18-012
1	6.0	G 1/8	1/4	RAP16-106	RAP18-106
	6.4			RAP16-106.4	RAP18-106.4
	8.0			RAP16-108	RAP18-108
	9.5			RAP16-109.5	RAP18-109.5
	10.0			RAP16-110	RAP18-110
	12.0			RAP16-112	RAP18-112
2	12.7	G 1/4	1/2	RAP16-212.7	RAP18-212.7
	13.5			RAP16-213.5	RAP18-213.5
	14.0			RAP16-214	RAP18-214
	15.0	G 3/8	5/8	RAP16-215	RAP18-215
	16.0			RAP16-216	RAP18-216
	17.2			RAP16-217.2	RAP18-217.2
18.0	RAP16-218	RAP18-218			
3	19.0	G 1/2	3/4	RAP16-319	RAP18-319
	20.0			RAP16-320	RAP18-320
	21.3			RAP16-321.3	RAP18-321.3
	22.0		1	RAP16-322	RAP18-322
	23.0			RAP16-323	RAP18-323
	25.0			RAP16-325	RAP18-325
4	26.9	G 3/4		RAP16-426.9	RAP18-426.9
	28.0			RAP16-428	RAP18-428
	30.0			RAP16-430	RAP18-430
5	32.0	G 1	1 1/4	RAP16-532	RAP18-532
	33.7			RAP16-533.7	RAP18-533.7
	35.0			RAP16-535	RAP18-535
	38.0	G 1 1/4	1 1/2	RAP16-538	RAP18-538
	40.0			RAP16-540	RAP18-540
	42.0			RAP16-542	RAP18-542
6	44.5	G 1 1/2	1 3/4	RAP16-644.5	RAP18-644.5
	45.0			RAP16-645	RAP18-645
	48.0			RAP16-648	RAP18-648
	50.0			RAP16-650	RAP18-650
	50.8		2	RAP16-650.8	RAP18-650.8
	52.0			RAP16-652	RAP18-652
	55.0			RAP16-655	RAP18-655
	57.0			RAP16-657	RAP18-657
			2 1/4		

Delivery in unassembled individual components.

¹⁾ Contrary to the illustration size 0 clamps are secured by only one screw.

* Only with cover plate, hexagon screws and locking washers.

Tube clamps series B (Twin-tube clamps) – Components

DIN 3015, part 3

Order code for clamp halves:

 Polypropylene – **RBP**
 Inside smooth – **RBPG**
 Polyamide 6 – **RBN**
 Rubber – **RBVG**

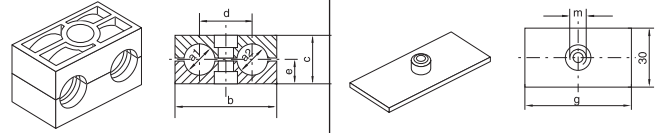
 (Please exchange standard abbreviation RBP
 in column for “clamp halves” as required.)

clamp size	Tube O.D. mm	Tube NB	Tube O.D.	1 part 2 clamp halves ¹⁾				weld plate			
				RBP... Order code	dimensions: b c d e				APB... Order code	dimensions: g m	
1	6.0	G 1/8	1/4 5/16 3/8	RBP106X RBP106.4X RBP108X RBP109.5X RBP110X RBP112X	36	27	20	13.5	APB1X	37	M6
	6.4										
	8.0										
	9.5										
	10.0										
12.0	Thickness: 3 mm										
2	12.7	G 1/4	1/2	RBP212.7X RBP213.5X RBP214X RBP215X RBP216X RBP217.2X RBP218X	53	26	29	13	APB2X	55	M8
	13.5										
	14.0										
	15.0	G 3/8	5/8								
	16.0										
	17.2										
18.0	Thickness: 5 mm										
3	19.0	G 1/2	3/4	RBP319X RBP320X RBP321.3X RBP322X RBP325X	67	37	36	18.5	APB3X	70	M8
	20.0										
	21.3		1								
	22.0										
	25.0										
4	26.9	G 3/4		RBP426.9X RBP428X RBP430X	82	42	45	21	APB4X	85	M8
	28.0										
	30.0										
5	32.0	G 1	1 1/4	RBP532X RBP533.7X RBP535X RBP538X RBP542X	106	54	56	27	APB5X	110	M8
	33.7										
	35.0	G 1 1/4	1 1/2								
	38.0										
	42.0										

Metal parts also available in stainless steel.

¹⁾ Twin-tube clamps with different outer tube diameters upon request.

Tube clamps

Tube clamps series B (Twin-tube clamps) – Components

DIN 3015, part 3

clamp size	weld plate, angled		mounting rail		rail nut					
	APW A... Order code	dimensions: d e Thickness:	TS...A/B Order code	dimensions: h	TM...A/B1 Order code	dimensions: a b c m				
1	APRB1X (5 clamps)	40 196 Thickness: 3 mm	TS11A/B1X TS11A/B2X TS14A/B1X TS14A/B2X TS30A/B1X TS30A/B2X	TS11: 11 TS14: 14 TS30: 30	TMA/TMB1VERZX	25.4	10.4	12	M6	
2	APRB2X (5 clamps)	58 288 Thickness: 5 mm			TMB2X	25.4	10.4	12	M8	
3	APRB3X (5 clamps)	72 358 Thickness: 5 mm								
4	APRB4X (5 clamps)	90 446 Thickness: 5 mm								
5	APRB5X (5 clamps)	112 558 Thickness: 5 mm								

Tube clamps series B (Twin-tube clamps) – Components

DIN 3015, part 3

clamp size	cover plate		hexagonal head	
	DP B... Order code	dimensions: b d	SS B... Order code	dimensions: d x L
1	DPB1X	34 6.6	SSLA2/SSB1X	M 06x35
2	DPB2X	51 8.6	SSB2X	M 08x35
3	DPB3X	64 8.6	SSB3X	M 08x45
4	DPB4X	78 8.6	SSB4X	M 08x50
5	DPB5X	102 8.6	SSB5X	M 08x60

Metal parts also available in stainless steel.

Tube clamps series B (Twin-tube clamps) – Components

DIN 3015, part 3

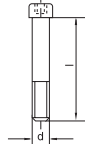

DIN 912

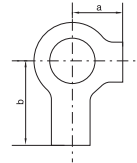
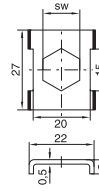
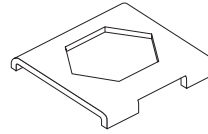
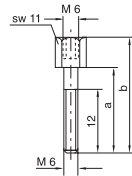
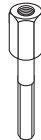

clamp size	socket head		stacking				locking plate ¹⁾		locking washer ²⁾			
	IS B... Order code	dimensions: d × L	AS B... Order code	dimensions:			SB B... Order code	dim.: SW	US... Order code	dimensions:		
				a	b	m	SW			a	b	
1	ISA4X (ISB1X)	M 06×35	ASA0X (ASB1X)	20	34	M6	11	SBB1X	11	USA/USB1X	9	18
2	ISB2X	M 08×35	ASB2X	20	33	M8	12	SBB2X	12	USB2X	11	20
3	ISB3X	M 08×45	ASB3X	29	44	M8	12					
4	ISB4X	M 08×50	ASB4X	34	49	M8	12					
5	ISB5X	M 08×60	ASB5X	47	62	M8	12					

¹⁾ The use of stacking screws necessitates the use of locking plates in the construction assembly!

²⁾ When assembling solid rubber clamps, covering plates, hexagon screws and locking washers must be used.
Metal parts also available in stainless steel.

Tube clamps series B – Complete range

Polypropylene – **RBP**
 Inside smooth – **RBPG**
 Polyamide 6 – **RBN**
 Rubber – **RBVG***

(As required please exchange standard abbreviation RBP in column for “Order code”)

2 clamp halves, weld plate, cover plate, hex. head bolt

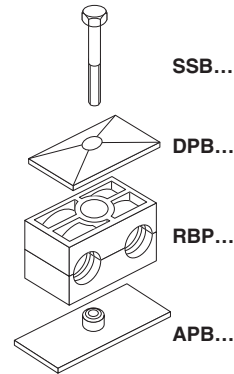

2 clamp halves, weld plate, cover plate, socket head bolt

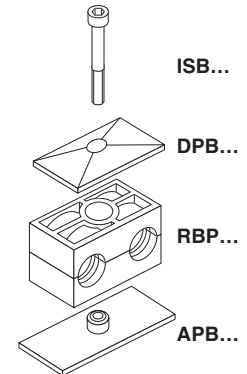

clamp size	Tube O.D. mm	Tube NB	Tube O.D.	Order code	Order code
1	6.0	G 1/8	1/4	RBP1-106	RBP3-106
	6.4			RBP1-106.4	RBP3-106.4
	8.0			RBP1-108	RBP3-108
	9.5			RBP1-109.5	RBP3-109.5
	10.0			RBP1-110	RBP3-110
	12.0			RBP1-112	RBP3-112
2	12.7	G 3/8	5/8	RBP1-212.7	RBP3-212.7
	13.5			RBP1-213.5	RBP3-213.5
	14.0			RBP1-214	RBP3-214
	15.0			RBP1-215	RBP3-215
	16.0			RBP1-216	RBP3-216
	17.2			RBP1-217.2	RBP3-217.2
	18.0			RBP1-218	RBP3-218
3	19.0	G 1/2	1	RBP1-319	RBP3-319
	20.0			RBP1-320	RBP3-320
	21.3			RBP1-321.3	RBP3-321.3
	22.0			RBP1-322	RBP3-322
	25.0			RBP1-325	RBP3-325
4	26.9	G 3/4		RBP1-426.9	RBP3-426.9
	28.0			RBP1-428	RBP3-428
	30.0			RBP1-430	RBP3-430
5	32.0	G 1 1/4	1 1/2	RBP1-532	RBP3-532
	33.7			RBP1-533.7	RBP3-533.7
	35.0			RBP1-535	RBP3-535
	38.0			RBP1-538	RBP3-538
	42.0			RBP1-542	RBP3-542

Delivery in unassembled individual components.

*Only with cover plate, hexagon screws and locking washers.

Tube clamps series B – Complete range

Polypropylene – **RBP**
 Inside smooth – **RBPG**
 Polyamide 6 – **RBN**
 Rubber – **RBVG***

(As required please exchange standard abbreviation RBP in column for "Order code")

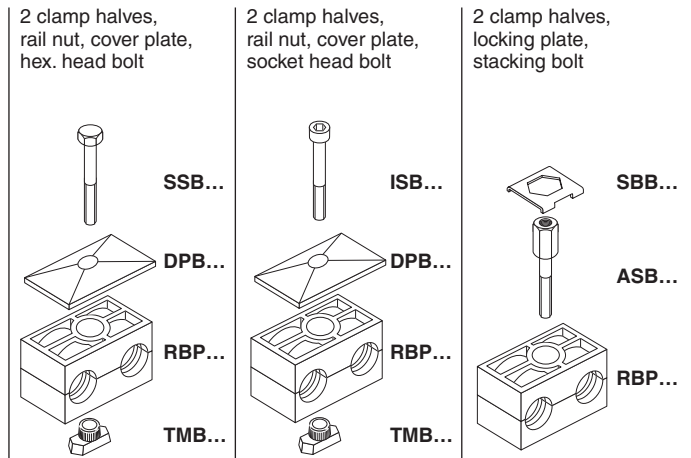

clamp size	Tube O.D. mm	Tube NB	Tube O.D.	Order code	Order code	Order code
1	6.0	G 1/8	1/4 5/16 3/8	RBP4-106	RBP5-106	RBP8-106
	6.4			RBP4-106.4	RBP5-106.4	RBP8-106.4
	8.0			RBP4-108	RBP5-108	RBP8-108
	9.5			RBP4-109.5	RBP5-109.5	RBP8-109.5
	10.0			RBP4-110	RBP5-110	RBP8-110
	12.0			RBP4-112	RBP5-112	RBP8-112
2	12.7	G 1/4 G 3/8	1/2 5/8	RBP4-212.7	RBP5-212.7	RBP8-212.7
	13.5			RBP4-213.5	RBP5-213.5	RBP8-213.5
	14.0			RBP4-214	RBP5-214	RBP8-214
	15.0			RBP4-215	RBP5-215	RBP8-215
	16.0			RBP4-216	RBP5-216	RBP8-216
	17.2			RBP4-217.2	RBP5-217.2	RBP8-217.2
18.0	RBP4-218	RBP5-218	RBP8-218			
3	19.0	G 1/2	3/4 1	RBP4-319	RBP5-319	RBP8-319
	20.0			RBP4-320	RBP5-320	RBP8-320
	21.3			RBP4-321.3	RBP5-321.3	RBP8-321.3
	22.0			RBP4-322	RBP5-322	RBP8-322
	25.0			RBP4-325	RBP5-325	RBP8-325
4	26.9	G 3/4		RBP4-426.9	RBP5-426.9	RBP8-426.9
	28.0			RBP4-428	RBP5-428	RBP8-428
	30.0			RBP4-430	RBP5-430	RBP8-430
5	32.0	G 1 G 1 1/4	1 1/4 1 1/2	RBP4-532	RBP5-532	RBP8-532
	33.7			RBP4-533.7	RBP5-533.7	RBP8-533.7
	35.0			RBP4-535	RBP5-535	RBP8-535
	38.0			RBP4-538	RBP5-538	RBP8-538
	42.0			RBP4-542	RBP5-542	RBP8-542

Delivery in unassembled individual components.

*Only with cover plate, hexagon screws and locking washers.



Tube clamps series C (Heavy series) – Components

DIN 3015, part 2

Order code for clamp halves:

- Polypropylene – **RCP**
- Inside smooth – **RCPG¹⁾**
- Polyamide 6 – **RCN¹⁾**
- Rubber – **RCVR**
- Aluminium – **RCA**

(Please exchange as required standard abbreviation RCP in column for “clamp halves”)

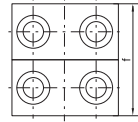
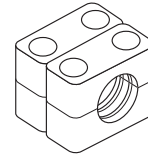
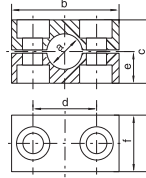
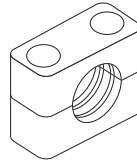

RCPD
(= 2XRCP...)

clamp size	Tube O.D. mm	Tube NB	Tube O.D.	1 part 2 clamp halves						1 part 4 clamp halves																
				RCP... Order code	dimensions:					RCPD... Order code	dimensions:															
				b	c	d	e	f	b	c	d	e	f													
1	6.0	G 1/8	5/16	RCP106X	55	32	33	16	30	RCPD106	55	32	33	16	60											
	8.0			RCP108X						RCPD108																
	10.0			RCP110X						RCPD110																
	12.0	RCP112X	RCPD112																							
	12.7	RCP112.7X	RCPD112.7																							
	13.5	RCP113.5X	RCPD113.5																							
	14.0	RCP114X	RCPD114																							
	15.0	RCP115X	RCPD115																							
	16.0	RCP116X	RCPD116																							
	17.2	RCP117.2X	RCPD117.2																							
18.0	RCP118X	RCPD118																								
2	19.0	G 1/2	3/4	RCP219X	70	48	45	24	30	RCPD219	70	48	45	24	60											
	20.0			RCP220X						RCPD220																
	21.3			RCP221.3X						RCPD221.3																
	22.0	RCP222X	RCPD222																							
	23.0	RCP223X	RCPD223																							
	25.0	RCP225X	RCPD225																							
	26.9	RCP226.9X	RCPD226.9																							
	28.0	RCP228X	RCPD228																							
	30.0	RCP230X	RCPD230																							
	3	30.0	G 1	1 1/4						RCP330X						85	60	60	30	30	RCPD330	85	60	60	30	60
32.0		RCP332X			RCPD332																					
33.7		RCP333.7X			RCPD333.7																					
35.0		RCP335X	RCPD335																							
38.0		RCP338X	RCPD338																							
39.0		RCP339X	RCPD339																							
40.0		RCP340X	RCPD340																							
42.0		RCP342X	RCPD342																							
4		38.0	G 1 1/4	1 1/2	RCP438X	115	90	90	45	45	RCPD438	115	90	90	45						90					
		39.0			RCP439X						RCPD439															
	40.0	RCP440X			RCPD440																					
	42.0	RCP442X	RCPD442																							
	45.0	RCP445X	RCPD445																							
	46.0	RCP446X	RCPD446																							
	48.3	RCP448.3X	RCPD448.3																							
	50.0	RCP450X	RCPD450																							
	51.0	RCP451X	RCPD451																							
	52.0	RCP452X	RCPD452																							
	55.0	RCP455X	RCPD455																							
	56.0	RCP456X	RCPD456																							
	57.0	RCP457X	RCPD457																							
	60.3	RCP460.3X	RCPD460.3																							
	63.0	RCP463X	RCPD463																							
	65.0	RCP465X	RCPD465																							
66.0	RCP466X	RCPD466																								

Continuation see next page ...

Tube clamps series C (Heavy series) – Components (Continued)

DIN 3015, part 2

Order code for clamp halves:

 Polypropylene – **RCP**
 Inside smooth – **RCPG**¹⁾
 Polyamide 6 – **RCN**¹⁾
 Rubber – **RCVR**
 Aluminium – **RCA**

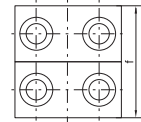
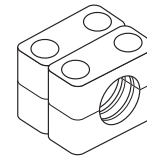
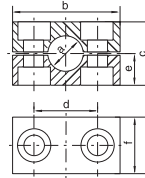
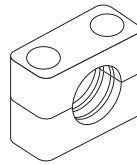
 (Please exchange as required standard abbreviation
 RCP in column for “clamp halves”)

RCPD
 (= 2XRCP...)

clamp size	Tube O.D. mm	Tube NB	Tube O.D.	1 part 2 clamp halves					1 part 4 clamp halves						
				RCP... Order code	dimensions:				RCPD... Order code	dimensions:					
				b	c	d	e	f	b	c	d	e	f		
5	70.0	G 2 1/2	3	RCP470X	152	120	122	60	60	RCPD470	152	120	122	60	120
	70.0			RCP570X						RCPD570					
	73.0			RCP573X						RCPD573					
	75.0			RCP575X						RCPD575					
	76.1			RCP576.1X						RCPD576.1					
	80.0	RCP580X	RCPD580												
	82.5	RCP582.5X	RCPD582.5												
	88.9	RCP588.9X	RCPD588.9												
	90.0	RCP590X	RCPD590												
6	90.0	G 3 1/2	4	RCP690X	205	170	168	85	80	RCPD690	205	170	168	85	160
	97.0			RCP697X						RCPD697					
	100.0			RCP6100X						RCPD6100					
	101.6	RCP6101.6X	RCPD6101.6												
	108.0	RCP6108X	RCPD6108												
	114.3	RCP6114.3X	RCPD6114.3												
	127.0	RCP6127X	RCPD6127												
7	127.0	G 5	5	RCP7127X	250	200	205	100	90	RCPD7127	250	200	205	100	180
	133.0			RCP7133X						RCPD7133					
	140.0			RCP7140X						RCPD7140					
	150.0	RCP7150X	RCPD7150												
	152.4	RCP7152.4X	RCPD7152.4												
	159.0	RCP7159X	RCPD7159												
	165.1	RCP7165.1X	RCPD7165.1												
	168.3	RCP7168.3X	RCPD7168.3												
	8	168.3	G 6	6						RCP8168.3X					
177.8		RCP8177.8X			RCPD8177.8										
193.7		RCP8193.7X			RCPD8193.7										
203.0		RCP8203X	RCPD8203												
219.1		RCP8219.1X	RCPD8219.1												
220.0		RCP8220X	RCPD8220												
9	219.1	G 8		RCP9219.1X	466	410	395	205	160	RCPD9219.1	466	410	395	205	320
	244.5			RCP9244.5X						RCPD9244.5					
	250.0			RCP9250X						RCPD9250					
	273.0			RCP9273X						RCPD9273					
	323.9			RCP9323.9X						RCPD9323.9					
10	355.6	G 10		RCP10355.6X	630	530	530	265	180	RCPD10355.6	630	530	530	265	360
	406.4	G 12		RCP10406.4X						RCPD10406.4					

Metal parts also available in stainless steel.

¹⁾ Only sizes 1–4

Tube clamps series C (Heavy series) – Components

DIN 3015, part 2

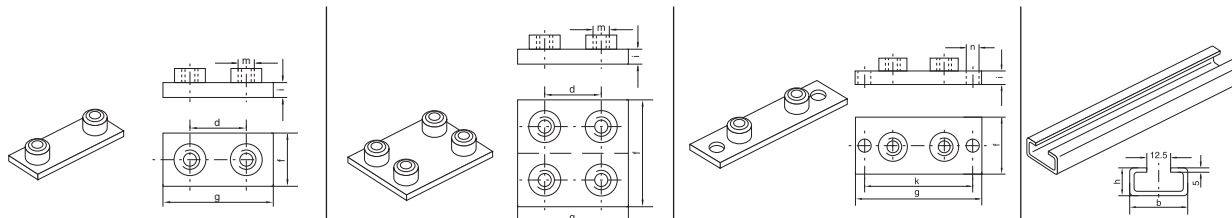

clamp size	AP C... Order code	weld plate dimensions:					APD C... Order code	double weld plate dimensions:					APL C... Order code	weld/screw plate dimensions:					mounting rail		
		d	f	g	i	m		d	f	g	i	m		g	f	i	k	n	TS C... Order code	dim.: b h	
1	APC1X	33	30	73	8	M10	APDC1X	33	60	73	8	M10	APLC1X	113	30	8	85	11	TSC1X (1 Meter)	40 22	
2	APC2X	45	30	85	8	M10	APDC2X	45	60	85	8	M10	APLC2X	125	30	8	97	11			
3	APC3X	60	30	100	8	M10	APDC3X	60	60	100	8	M10	APLC3X	140	30	8	112	11			TSC2X (2 Meter)
4	APC4X	90	45	140	10	M12	APDC4X	90	90	140	10	M12	APLC4X	190	45	10	160	14			
5	APC5X	122	60	180	10	M16	APDC5X	122	120	180	10	M16	APLC5X	240	60	10	205	18			
6	APC6X	168	80	225	15	M20	APDC6X	168	160	225	15	M20	APLC6X	310	80	15	270	22			
7	APC7X	205	90	270	15	M24	APDC7X	205	180	270	15	M24	APLC7X	370	90	15	320	26			
8	APC8X	265	120	340	25	M30	APDC8X	265	240	340	25	M30	APLC8X	450	120	25	390	33			
9	APC9X	395	160	520	30	M30	APDC9X	395	324	520	30	M30									
10	APC10X	530	180	680	30	M30	APDC10X	530	364	680	30	M30									

Metal parts also available in stainless steel.

Complete programme range please refer to page S28.

Tube clamps series C (Heavy series) – Components

DIN 3015, part 2

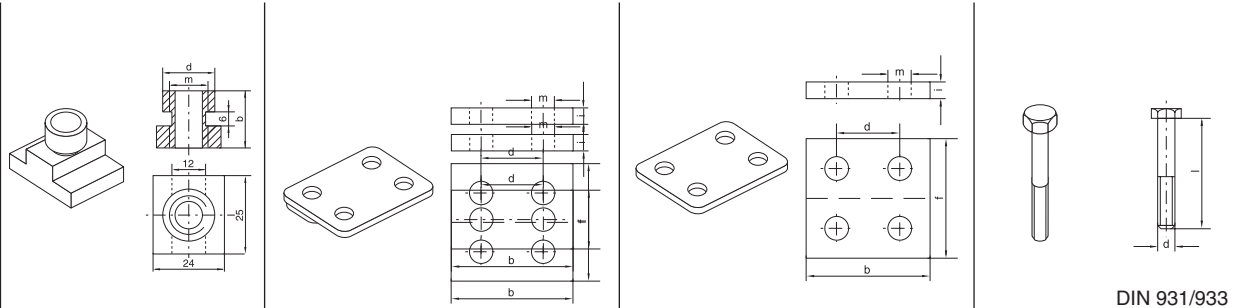

clamp size	rail nut			cover plate					double cover plate					hexagon head				
	TM C... Order code	dimensions:			DP C... Order code	dimensions:					DPD C... Order code	dimensions:					SS C... Order code	dimensions:
		b	d	m		b	d	f	i	m		b	d	f	i	m		d × L
1	TMC1X	20	17.8	M10	DPC1X	55	33	30	8	11	DPDC1X	55	33	60	8	11	SSC1X	M 10×45
2					DPC2X	70	45	30	8	11	DPDC2X	70	45	60	8	11	SSC2X	M 10×60
3					DPC3X	85	60	30	8	11	DPDC3X	85	60	60	8	11	SSC3X	M 10×70
4	TMC4X	23	19.8	M12	DPC4X	115	90	45	10	14	DPDC4X	115	90	90	10	14	SSC4X	M 12×100
5					DPC5X	152	122	60	10	18	DPDC5X	152	122	120	10	18	SSC5X	M 16×130
6					DPC6X	205	168	80	15	22	DPDC6X	205	168	160	15	22	SSC6X	M 20×190
7					DPC7X	250	205	90	15	26	DPDC7X	250	205	180	15	26	SSC7X	M 24×220
8					DPC8X	320	265	120	25	33	DPDC8X	320	265	240	25	33	SSC8X	M 30×300
9					DPC9X	466	395	160	30	35	DPDC9X	466	395	324	30	35	SSC9X	M 30×450
10					DPC10X	630	530	364	30	35	DPDC10X	630	530	364	30	35	SSC10X	M 30×560

Metal parts also available in stainless steel.

Tube clamps series C (Heavy series) – Components

DIN 3015, part 2

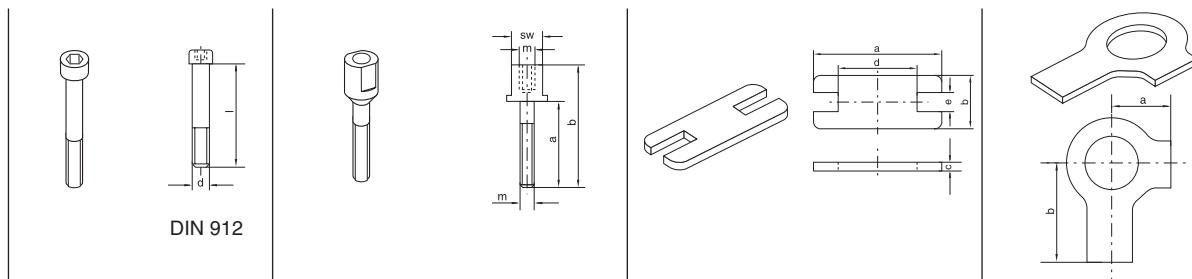

clamp size	socket head		AS C... Order code	stacking				locking plate ¹⁾					locking washer ²⁾		
	IS C... Order code	dimensions: d × L		dimensions:	a	b	m	SW	SP C... Order code	dimensions:	a	b	c	d	e
1	ISC1X	M 10×45	ASC1X	25	51	M10	15	SPC1X	55	30	8	14	15.5	USC1X	13 22
2	ISC2X	M 10×60	ASC2X	40	66	M10	15	SPC2X	70	30	8	26	15.5		
3	ISC3X	M 10×70	ASC3X	50	76	M10	15	SPC3X	85	30	8	41	15.5		
4	ISC4X	M 12×100	ASC4X	85	112	M12	17	SPC4X	115	45	10	69	17.5	USC4X	15 28
5	ISC5X	M 16×130	ASC5X	110	146	M16	21	SPC5X	152	60	10	97	21.5	USC5X	18 32
6	ISC6X	M 20×190	ASC6X	155	206	M20	27	SPC6X	205	80	15	137	27.5	USC6X	21 36
7	ISC7X	M 24×220	ASC7X	185	245	M24	30	SPC7X	250	90	15	169	30.5	USC7X	25 42
8	ISC8X	M 30×300	ASC8X	250	330	M30	36	SPC8X	320	120	25	219	36.5	USC8X	32 52

¹⁾ The use of stacking screws necessitates the use of locking plates in the construction assembly!

²⁾ When assembling solid rubber clamps, covering plates, hexagon screws and locking washers must be used. Metal parts also available in stainless steel.

Tube clamps series C – Complete range

Polypropylene – **RCP**
 Inside smooth – **RCPG¹**
 Polyamide 6 – **RCN**
 Rubber – **RCVR***
 Aluminium – **RCA**

(As required please exchange standard abbreviation
 RCP in column for "Order code")

2 clamp halves, weld plate,
 cover plate, hex. head bolt

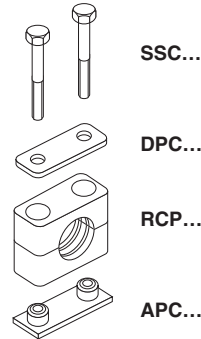

2 clamp halves, weld plate,
 cover plate, socket head bolt

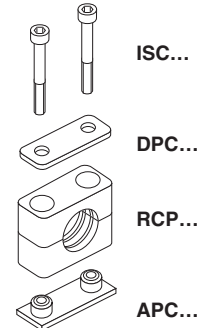

clamp size	Tube O.D. mm	Tube NB	Tube O.D.	Order code	Order code
1	6.0	G 1/8	5/16	RCP1-106	RCP2-106
	8.0			RCP1-108	RCP2-108
	10.0			RCP1-110	RCP2-110
	12.0			RCP1-112	RCP2-112
	12.7			RCP1-112.7	RCP2-112.7
	13.5	G 1/4	1/2	RCP1-113.5	RCP2-113.5
				RCP1-114	RCP2-114
				RCP1-115	RCP2-115
				RCP1-116	RCP2-116
				RCP1-117.2	RCP2-117.2
RCP1-118				RCP2-118	
2	19.0	G 1/2	3/4	RCP1-219	RCP2-219
	20.0			RCP1-220	RCP2-220
	21.3			RCP1-221.3	RCP2-221.3
	22.0			RCP1-222	RCP2-222
	23.0	G 3/4	1	RCP1-223	RCP2-223
				RCP1-225	RCP2-225
				RCP1-226.9	RCP2-226.9
				RCP1-228	RCP2-228
30.0	RCP1-230	RCP2-230			
3	30.0	G 1	1 1/4	RCP1-330	RCP2-330
	32.0			RCP1-332	RCP2-332
	33.7			RCP1-333.7	RCP2-333.7
	35.0	G 1 1/4	1 1/2	RCP1-335	RCP2-335
				RCP1-338	RCP2-338
				RCP1-340	RCP2-340
42.0	RCP1-342	RCP2-342			
4	38.0	G 1 1/4	1 1/2	RCP1-438	RCP2-438
	40.0			RCP1-440	RCP2-440
	42.0			RCP1-442	RCP2-442
	45.0	G 1 1/2	2	RCP1-445	RCP2-445
				RCP1-448.3	RCP2-448.3
	48.3	G 2	2 1/4	RCP1-450	RCP2-450
				RCP1-451	RCP2-451
	50.0	RCP1-452	RCP2-452		
	51.0	RCP1-455	RCP2-455		
	52.0	RCP1-457	RCP2-457		
	55.0	RCP1-460.3	RCP2-460.3		
	57.0	RCP1-463	RCP2-463		
	60.3	RCP1-465	RCP2-465		
63.0	RCP1-466	RCP2-466			
65.0	RCP1-470	RCP2-470			
70.0					

Continuation see next page ...

Tube clamps series C – Complete range (Continued)

Polypropylene – **RCP**
 Inside smooth – **RCPG¹⁾**
 Polyamide 6 – **RCN**
 Rubber – **RCVR***
 Aluminium – **RCA**

(As required please exchange standard abbreviation
 RCP in column for "Order code")

2 clamp halves, weld plate,
 cover plate, hex. head bolt

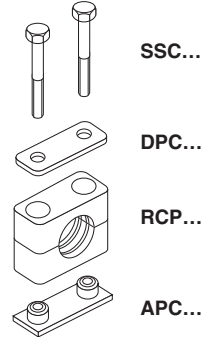

2 clamp halves, weld plate,
 cover plate, socket head bolt

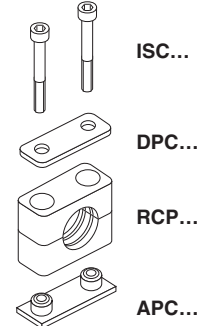

clamp size	Tube O.D. mm	Tube NB	Tube O.D.	Order code	Order code		
5	70.0	G 2 1/2	3	RCP1-570	RCP2-570		
	73.0			RCP1-573	RCP2-573		
	75.0			RCP1-575	RCP2-575		
	76.1			RCP1-576.1	RCP2-576.1		
	80.0	G 3	3 1/4	RCP1-580	RCP2-580		
	82.5			RCP1-582.5	RCP2-582.5		
	88.9			RCP1-588.9	RCP2-588.9		
90.0			RCP1-590	RCP2-590			
6	90.0	G 3 1/2	4	RCP1-690	RCP2-690		
	97.0			RCP1-697	RCP2-697		
	100.0			RCP1-6100	RCP2-6100		
	101.6			RCP1-6101.6	RCP2-6101.6		
	108.0	G 4	4 1/4	RCP1-6108	RCP2-6108		
	114.3			RCP1-6114.3	RCP2-6114.3		
	127.0			RCP1-6127	RCP2-6127		
7	127.0	G 5	5	RCP1-7127	RCP2-7127		
	133.0			RCP1-7133	RCP2-7133		
	140.0			RCP1-7140	RCP2-7140		
	150.0	G 5 1/2	5 1/2	RCP1-7150	RCP2-7150		
	152.4			RCP1-7152.4	RCP2-7152.4		
	159.0			G 6	6	RCP1-7159	RCP2-7159
	165.1					RCP1-7165.1	RCP2-7165.1
168.3		6 5/8	RCP1-7168.3	RCP2-7168.3			
8	168.3	G 8	6 5/8	RCP1-8168.3	RCP2-8168.3		
	177.8		7	RCP1-8177.8	RCP2-8177.8		
	193.7		7 5/8	RCP1-8193.7	RCP2-8193.7		
	203.0		8 5/8	RCP1-8203	RCP2-8203		
	219.1			RCP1-8219.1	RCP2-8219.1		
	220.0			RCP1-8220	RCP2-8220		

Delivery in unassembled individual components.

¹⁾ Only sizes 1–4

* Only with cover plate, hexagon screws and locking washers (only sizes 1–4).

Tube clamps series C – Complete range

Polypropylene – **RCP**
 Inside smooth – **RCPG¹**
 Polyamide 6 – **RCN**
 Rubber – **RCVR***
 Aluminium – **RCA**

(As required please exchange standard abbreviation
 RCP in column for "Order code")

2 clamp halves,
 rail nuts, cover plate,
 hex. head bolts

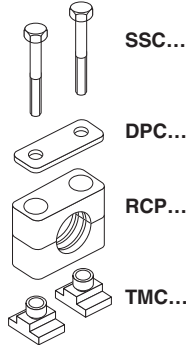

2 clamp halves,
 rail nuts, cover plate,
 socket head bolts

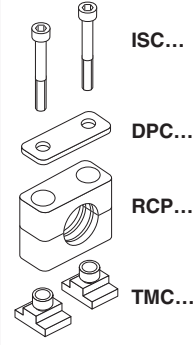

2 clamp halves, locking
 plate, stacking bolts

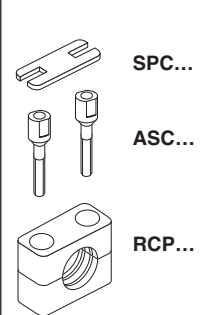

clamp size	Tube O.D. mm	Tube NB	Tube O.D.	Order code	Order code	Order code
1	6.0	G 1/8	5/16	RCP3-106	RCP4-106	RCP5-106
	8.0			RCP3-108	RCP4-108	RCP5-108
	10.0			RCP3-110	RCP4-110	RCP5-110
	12.0			RCP3-112	RCP4-112	RCP5-112
	12.7	G 1/4	1/2	RCP3-112.7	RCP4-112.7	RCP5-112.7
	13.5			RCP3-113.5	RCP4-113.5	RCP5-113.5
	14.0			RCP3-114	RCP4-114	RCP5-114
	15.0			RCP3-115	RCP4-115	RCP5-115
	16.0	G 3/8	5/8	RCP3-116	RCP4-116	RCP5-116
	17.2			RCP3-117.2	RCP4-117.2	RCP5-117.2
18.0	RCP3-118			RCP4-118	RCP5-118	
2	19.0	G 1/2	3/4	RCP3-219	RCP4-219	RCP5-219
	20.0			RCP3-220	RCP4-220	RCP5-220
	21.3			RCP3-221.3	RCP4-221.3	RCP5-221.3
	22.0			RCP3-222	RCP4-222	RCP5-222
	23.0	G 3/4	1	RCP3-223	RCP4-223	RCP5-223
	25.0			RCP3-225	RCP4-225	RCP5-225
	26.9			RCP3-226.9	RCP4-226.9	RCP5-226.9
	28.0			RCP3-228	RCP4-228	RCP5-228
	30.0			RCP3-230	RCP4-230	RCP5-230
3	30.0	G 1	1 1/4	RCP3-330	RCP4-330	RCP5-330
	32.0			RCP3-332	RCP4-332	RCP5-332
	33.7			RCP3-333.7	RCP4-333.7	RCP5-333.7
	35.0			RCP3-335	RCP4-335	RCP5-335
	38.0	G 1 1/4	1 1/2	RCP3-338	RCP4-338	RCP5-338
	40.0			RCP3-340	RCP4-340	RCP5-340
	42.0			RCP3-342	RCP4-342	RCP5-342
4	38.0	G 1 1/4	1 1/2	RCP3-438	RCP4-438	RCP5-438
	40.0			RCP3-440	RCP4-440	RCP5-440
	42.0			RCP3-442	RCP4-442	RCP5-442
	45.0			RCP3-445	RCP4-445	RCP5-445
	48.3	G 1 1/2	2	RCP3-448.3	RCP4-448.3	RCP5-448.3
	50.0			RCP3-450	RCP4-450	RCP5-450
	51.0			RCP3-451	RCP4-451	RCP5-451
	52.0			RCP3-452	RCP4-452	RCP5-452
	55.0	G 2	2 1/4	RCP3-455	RCP4-455	RCP5-455
	57.0			RCP3-457	RCP4-457	RCP5-457
	60.3			RCP3-460.3	RCP4-460.3	RCP5-460.3
	63.0			RCP3-463	RCP4-463	RCP5-463
	65.0			RCP3-465	RCP4-465	RCP5-465
	70.0			RCP3-470	RCP4-470	RCP5-470

Continuation see next page ...

Tube clamps series C – Complete range (Continued)

Polypropylene – **RCP**
 Inside smooth – **RCPG**¹⁾
 Polyamide 6 – **RCN**
 Rubber – **RCVR***
 Aluminium – **RCA**

(As required please exchange standard abbreviation
 RCP in column for "Order code")

2 clamp halves, locking
 plate, stacking bolts

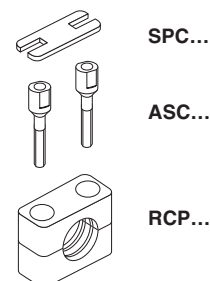

clamp size	Tube O.D. mm	Tube NB	Tube O.D.	Order code
5	70.0	G 2 1/2	3	RCP5-570
	73.0			RCP5-573
	75.0			RCP5-575
	76.1	G 3	3 1/4	RCP5-576.1
	80.0			RCP5-580
	82.5			RCP5-582.5
	88.9			RCP5-588.9
90.0	RCP5-590			
6	90.0	G 3 1/2	4	RCP5-690
	97.0			RCP5-697
	100.0			RCP5-6100
	101.6	G 4	4 1/4	RCP5-6101.6
	108.0			RCP5-6108
	114.3			RCP5-6114.3
127.0	5	RCP5-6127		
7	127.0	G 5	5 1/4	RCP5-7127
	133.0			RCP5-7133
	140.0			RCP5-7140
	150.0	G 5 1/2	5 1/2	RCP5-7150
	152.4			RCP5-7152.4
	159.0	G 6	6	RCP5-7159
	165.1			RCP5-7165.1
168.3	RCP5-7168.3			
8	168.3	G 8	6 5/8	RCP5-8168.3
	177.8			RCP5-8177.8
	193.7			RCP5-8193.7
	203.0			RCP5-8203
	219.1			RCP5-8219.1
	220.0			RCP5-8220

Delivery in unassembled individual components.

¹⁾ Only sizes 1–4

* Only with cover plate, hexagon screws and locking washers (only sizes 1–4).

Tube clamps series C – Complete range

Polypropylene – **RCPD**
 Inside smooth – **RCPDG¹**
 Polyamide 6 – **RCND**
 Rubber – **RCVDR***
 Aluminium – **RCAD**

(As required please exchange standard abbreviation
 RCP in column for "Order code")

4 clamp halves, double weld plate,
 double cover plate, hex. head bolts

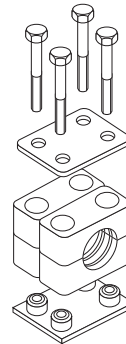

SSC...

DPDC...

RCPD...
 (=2XRCP...)

APDC...

4 clamp halves, double weld
 plate, double cover plate, socket
 head bolts

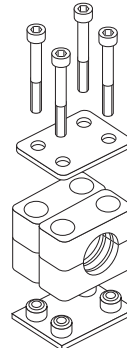

ISC...

DPDC...

RCPD...
 (=2XRCP...)

APDC...

clamp size	Tube O.D. mm	Tube NB	Tube O.D.	Order code	Order code
1	6.0	G 1/8	5/16	RCPD1-106	RCPD2-106
	8.0			RCPD1-108	RCPD2-108
	10.0			RCPD1-110	RCPD2-110
	12.0			RCPD1-112	RCPD2-112
	12.7	G 1/4	1/2	RCPD1-112.7	RCPD2-112.7
	13.5			RCPD1-113.5	RCPD2-113.5
	14.0			RCPD1-114	RCPD2-114
	15.0			RCPD1-115	RCPD2-115
	16.0			RCPD1-116	RCPD2-116
	17.2			RCPD1-117.2	RCPD2-117.2
18.0	G 3/8	5/8	RCPD1-118	RCPD2-118	
2	19.0	G 1/2	3/4	RCPD1-219	RCPD2-219
	20.0			RCPD1-220	RCPD2-220
	21.3			RCPD1-221.3	RCPD2-221.3
	22.0			RCPD1-222	RCPD2-222
	23.0	G 3/4	1	RCPD1-223	RCPD2-223
	25.0			RCPD1-225	RCPD2-225
	26.9			RCPD1-226.9	RCPD2-226.9
	28.0			RCPD1-228	RCPD2-228
	30.0			RCPD1-230	RCPD2-230
3	30.0	G 1	1 1/4	RCPD1-330	RCPD2-330
	32.0			RCPD1-332	RCPD2-332
	33.7			RCPD1-333.7	RCPD2-333.7
	35.0			RCPD1-335	RCPD2-335
	38.0	G 1 1/4	1 1/2	RCPD1-338	RCPD2-338
	40.0			RCPD1-340	RCPD2-340
	42.0			RCPD1-342	RCPD2-342
4	38.0	G 1 1/4	1 1/2	RCPD1-438	RCPD2-438
	40.0			RCPD1-440	RCPD2-440
	42.0			RCPD1-442	RCPD2-442
	45.0			RCPD1-445	RCPD2-445
	48.3	G 1 1/2		RCPD1-448.3	RCPD2-448.3
	50.0			RCPD1-450	RCPD2-450
	51.0	G 2	2	RCPD1-451	RCPD2-451
	52.0			RCPD1-452	RCPD2-452
	55.0			RCPD1-455	RCPD2-455
	57.0			RCPD1-457	RCPD2-457
	60.3	G 2	2 1/4	RCPD1-460.3	RCPD2-460.3
	63.0			RCPD1-463	RCPD2-463
	65.0			RCPD1-465	RCPD2-465
	70.0			RCPD1-470	RCPD2-470

Continuation see next page ...

Tube clamps series C – Complete range (Continued)

Polypropylene – **RCPD**
 Inside smooth – **RCPDG¹⁾**
 Polyamide 6 – **RCND**
 Rubber – **RCVDR***
 Aluminium – **RCAD**

(As required please exchange standard abbreviation RCP in column for "Order code")

4 clamp halves, double weld plate, double cover plate, hex. head bolts

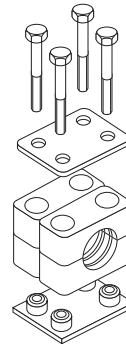

SSC...
DPDC...
RCPD...
(=2XRCP...)
APDC...

4 clamp halves, double weld plate, double cover plate, socket head bolts

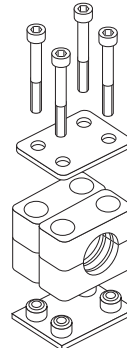

ISC...
DPDC...
RCPD...
(=2XRCP...)
APDC...

clamp size	Tube O.D. mm	Tube NB	Tube O.D.	Order code	Order code
5	70.0	G 2 1/2	3	RCPD1-570	RCPD2-570
	73.0			RCPD1-573	RCPD2-573
	75.0			RCPD1-575	RCPD2-575
	76.1			RCPD1-576.1	RCPD2-576.1
	80.0	G 3	3 1/4	RCPD1-580	RCPD2-580
	82.5			RCPD1-582.5	RCPD2-582.5
	88.9			RCPD1-588.9	RCPD2-588.9
90.0			RCPD1-590	RCPD2-590	
6	90.0	G 3 1/2	4	RCPD1-690	RCPD2-690
	97.0			RCPD1-697	RCPD2-697
	100.0			RCPD1-6100	RCPD2-6100
	101.6			RCPD1-6101.6	RCPD2-6101.6
	108.0	G 4	4 1/2	RCPD1-6108	RCPD2-6108
	114.3			RCPD1-6114.3	RCPD2-6114.3
127.0		5	RCPD1-6127	RCPD2-6127	
7	127.0	G 5	5 1/4	RCPD1-7127	RCPD2-7127
	133.0			RCPD1-7133	RCPD2-7133
	140.0			RCPD1-7140	RCPD2-7140
	150.0	G 5 1/2	6	RCPD1-7150	RCPD2-7150
	152.4			RCPD1-7152.4	RCPD2-7152.4
	159.0	G 6	6 1/4	RCPD1-7159	RCPD2-7159
	165.1			RCPD1-7165.1	RCPD2-7165.1
168.3	RCPD1-7168.3			RCPD2-7168.3	
8	168.3	G 8	6 5/8	RCPD1-8168.3	RCPD2-8168.3
	177.8		7	RCPD1-8177.8	RCPD2-8177.8
	193.7		7 5/8	RCPD1-8193.7	RCPD2-8193.7
	203.0		8 5/8	RCPD1-8203	RCPD2-8203
	219.1			RCPD1-8219.1	RCPD2-8219.1
220.0			RCPD1-8220	RCPD2-8220	

Delivery in unassembled individual components.

¹⁾ Only sizes 1–4

* Only with cover plate, hexagon screws and locking washers (only sizes 1–4).

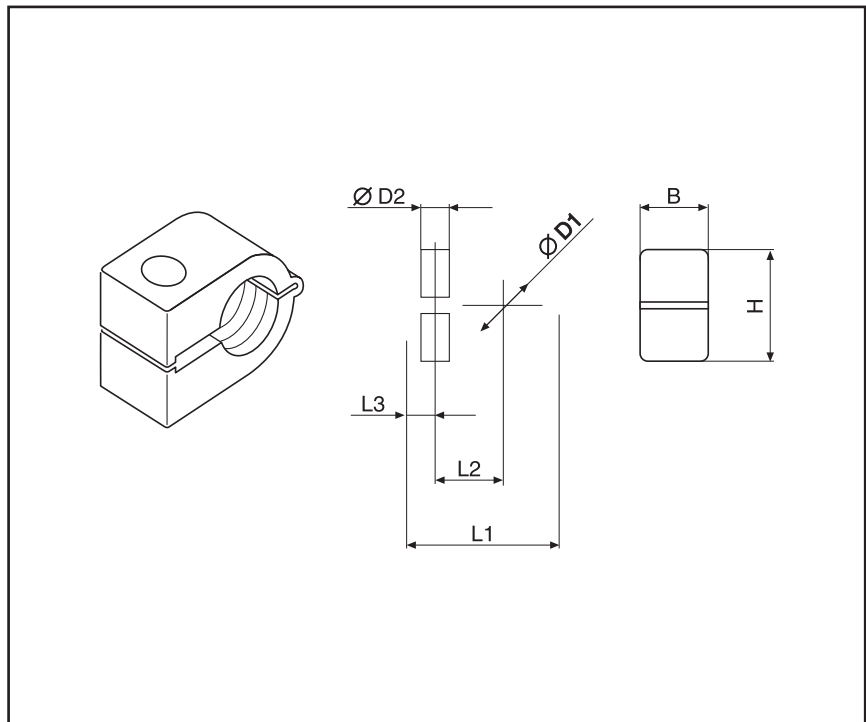
Tube clamps series O

Order code for tube clamps:

 Polypropylene **ROP***

 Polyamide **RON***

 * Supplement with size and tube \varnothing mm.
 (e.g. ROP 106X)

Packing standard 200 pieces.

Areas of Application:

- pneumatics
 - automotive technology
 - machine tool industry
 - lubrication
 - naval technologie
- also suitable for cables and hoses.

Clamp-size	O.D. mm	Tube \varnothing D1		Order code Polypropylene ROP	Order code Polyamide RON	L1	L2	L3	B	H	\varnothing D2	
		Tube NB	Inch									
1	6.0			ROP 106X	RON 106X	22	9	7	14.5	13.5	6.5	
	6.4		1/4	ROP 106.4X	RON 106.4X							
	8.0			ROP 108X	RON 108X							
2	8.0	1/8	3/8	ROP 208X	RON 208X	27	11	7	14.5	18.5	6.5	
	9.5			ROP 209.5X	RON 209.5X							
	10.0			ROP 210X	RON 210X							
	12.0			ROP 212X	RON 212X							
	12.7			ROP 212.7X	RON 212.7X							
3	10.0	1/8	1/2	ROP 310X	RON 310X	33	15	7	14.5	23.5	6.5	
	12.0			ROP 312X	RON 312X							
	12.7			ROP 312.7X	RON 312.7X							
	13.5	1/4	5/8	ROP 313.5X	RON 313.5X							
	14.0			ROP 314X	RON 314X							
	15.0			ROP 315X	RON 315X							
	16.0			ROP 316X	RON 316X							
4	14.0	3/8	5/8	ROP 414X	RON 414X	40	19	6	14.5	30.5	6.5	
	15.0			ROP 415X	RON 415X							
	16.0			ROP 416X	RON 416X							
	17.2			ROP 417.2X	RON 417.2X							
	18.0			3/4								ROP 418X
	19.0	ROP 419X	RON 419X									
	20.0	ROP 420X	RON 420X									
	21.3	1/2	ROP 421.3X									RON 421.3X
	22.0		ROP 422X									RON 422X

Double-Tube clamps series O

Order code for tube clamps:

Polypropylen **ROPD***
 Polyamid **ROND***

*Supplement with size and tube \varnothing mm.
 (e.g. ROPD 106X)

*Different diameter on request

Order code for cover plate:

DPO*

*Supplement with size.

Material: Galvanized steel
 Stainless steel upon request

Areas of Application:

- pneumatics
 - automotive technology
 - machine tool industry
 - lubrication
 - naval technologie
- also suitable for cables and hoses.

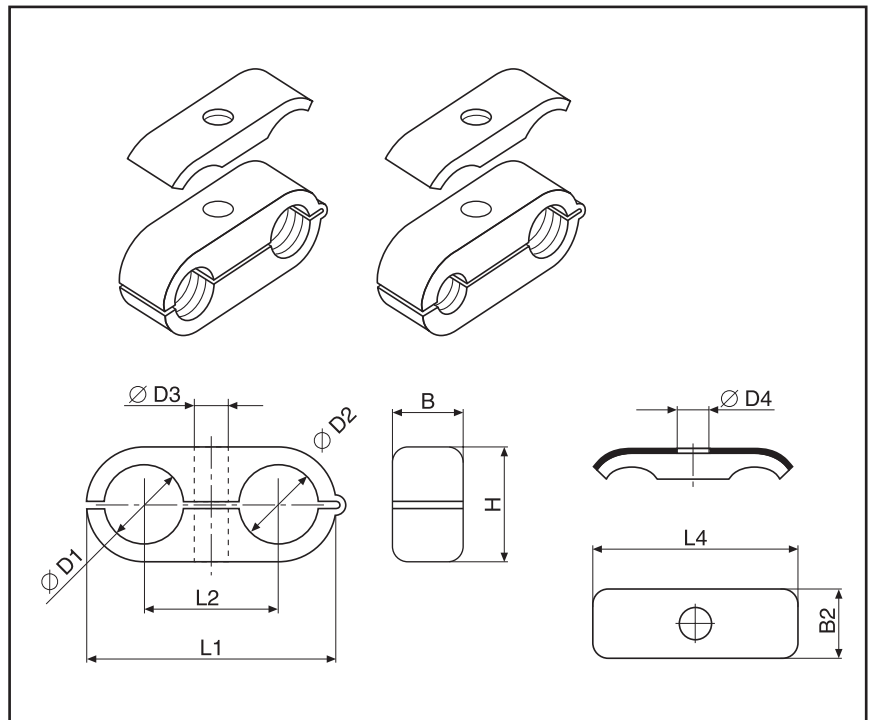

Clamp-size	Tube \varnothing D1/D2			Order code Polypropylene ROPD	Order code Cover plate DPO	L1	L2	B	H	\varnothing D3	L4	B2	\varnothing D4	
	O.D. mm	Tube NB	Inch											
1	6.0		1/4	ROPD 106X	DPO1X	32	18	14.5	13.5	6.5	29.0	16.3	6.5	
	6.4			ROPD 106.4X	DPO1X									
	8.0			ROPD 108X	DPO1X									
2	8.0	1/8	3/8	ROPD 208X	DPO2X	41	22	14.5	18.5	6.5	40.0	16.3	6.5	
	9.5				ROPD 209.5X									DPO2X
	10.0				ROPD 210X									DPO2X
	12.0				ROPD 212X									DPO2X
	12.7				ROPD 212.7X									DPO2X
3	10.0	1/8	1/2	ROPD 310X	DPO3X	54	30	14.5	23.5	6.5	50.5	16.5	6.5	
	12.0				ROPD 312X									DPO3X
	12.7				ROPD 312.7X									DPO3X
	13.5			1/4	ROPD 313.5X									DPO3X
	14.0				ROPD 314X									DPO3X
	15.0				ROPD 315X									DPO3X
	16.0				ROPD 316X									DPO3X
4	14.0	3/8	5/8	ROPD 414X	DPO4X	69	38	14.5	30.5	6.5	63.0	16.5	6.5	
	15.0				ROPD 415X									DPO4X
	16.0				ROPD 416X									DPO4X
	17.2				ROPD 417.2X									DPO4X
	18.0			3/4	ROPD 418X									DPO4X
	19.0				ROPD 419X									DPO4X
	20.0				ROPD 420X									DPO4X
	21.3				1/2									ROPD 421.3X
	22.0			ROPD 422X										DPO4X

Hydraulic steel-clamps

Hydraulic steel-clamps

Order code

W1: steel coating ZN

* please add. $\varnothing D$

HSRS-*

HSRS hydraulic steel-clamps are mainly used in the field of building machinery.

The support-block is welded to the machine body or another component either in upend or flat position. The tube-clamp is screwed on.

The robust construction of the clamp has an impact- and vibrationabsorbing effect. The small dimension/ height of the clamp allows hydraulic cables to be fitted later on – e. g. for installing additional equipment to building machinery.

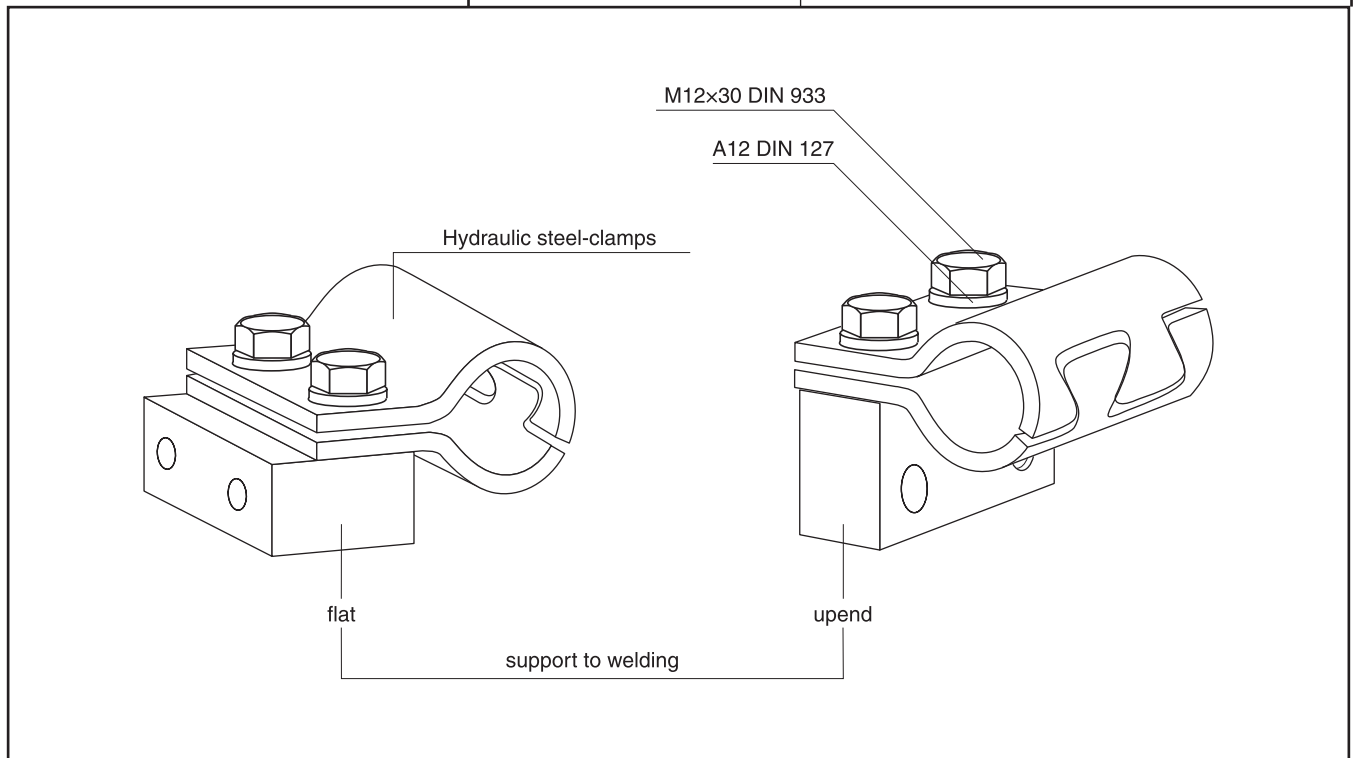
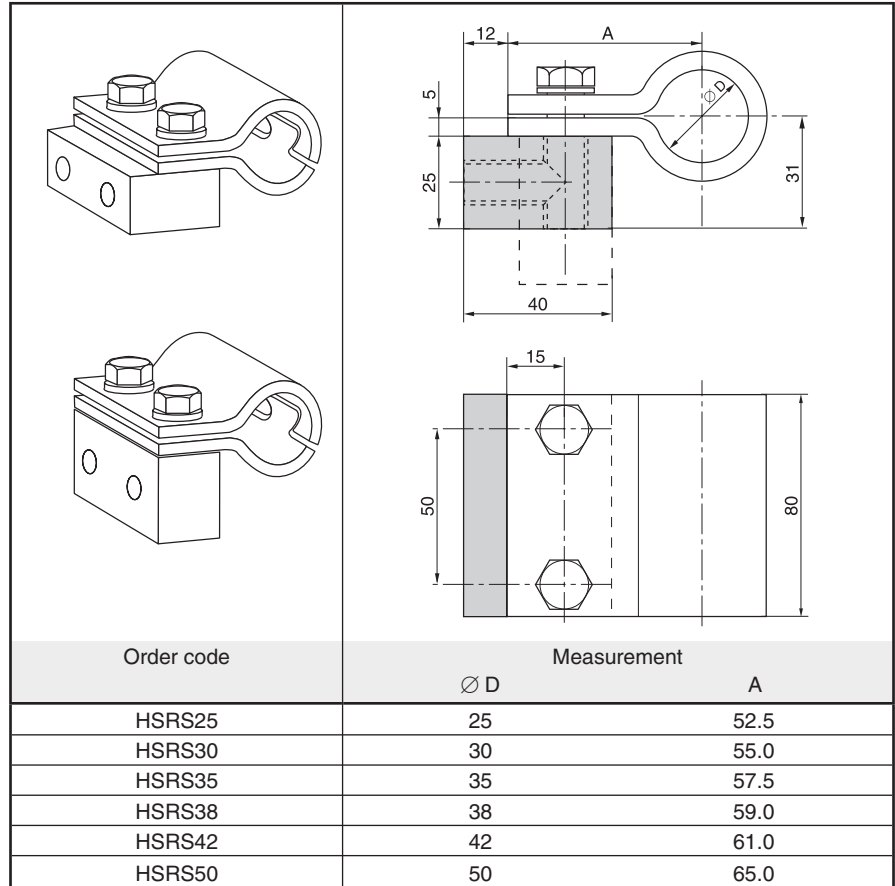

Hydraulic steel-clamps

Elastomere Inlay for HSRS

Order code **EE-***
 * complete outside tube diameter

Hydraulic steel tube clamp HSRS also available with Elastomere inlay

The advantages:

- complete outside tube diameter
- Safe fastening method even for very sensitive tube and hoses lines
- Only one clamp for different tube diameters

Material:

Santoprene 64 Shore

- high oil and weathering resistance
- temperature stability between -40 °C and +125°C

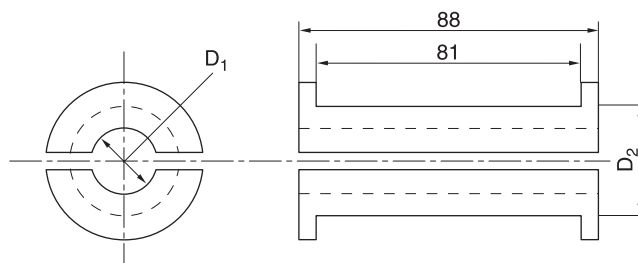

Order code	Nominal size D2	mm O.D. D1
EE12X	HSRS25	12
EE15X		15
EE20X	HSRS30	20
EE25X	HSRS35	25
EE30X	HSRS42	30
EE35X	HSRS50	35
EE38X		38
EE42X		42

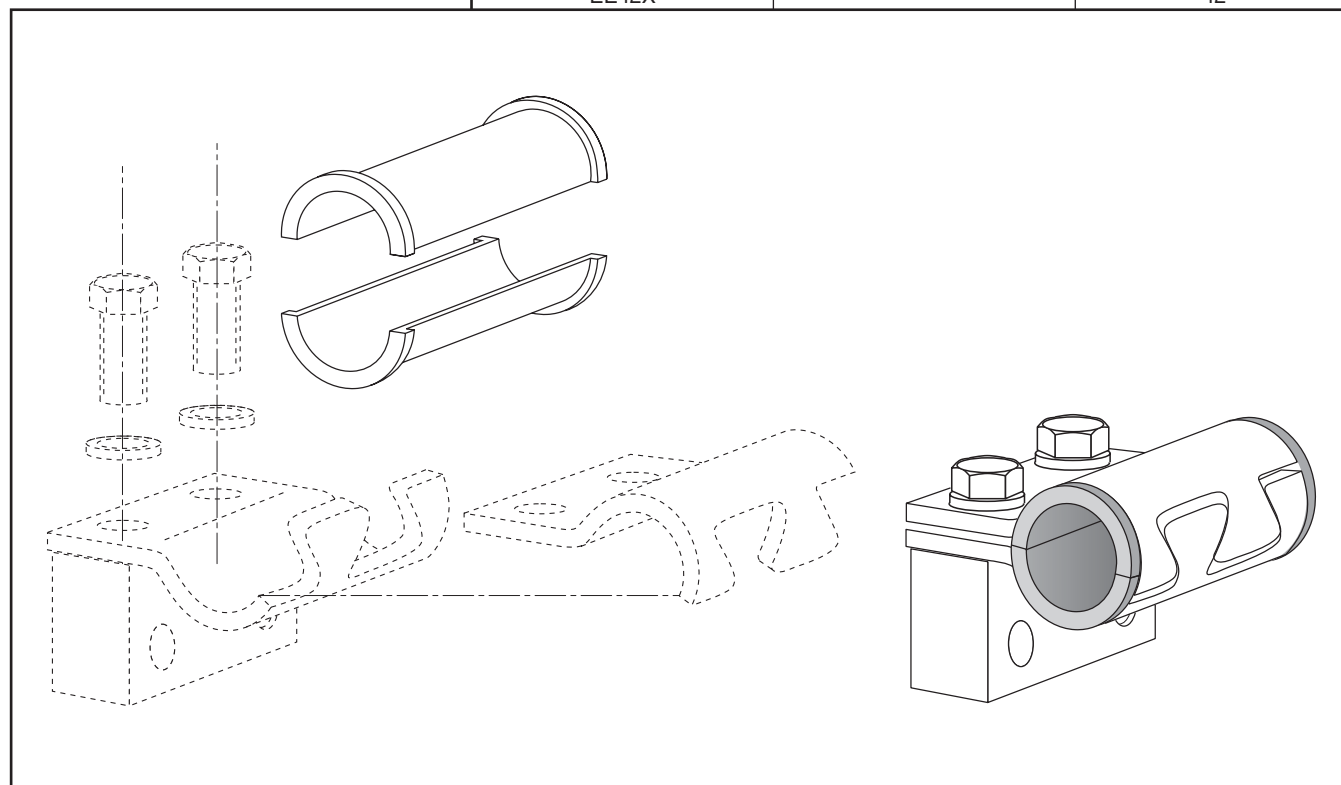

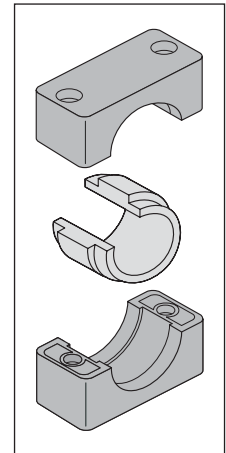
Tube Clamps with Elastomer Inlay

Light Constr. Series
Order codes for clamp-halves:

 Polypropylene – **RAPE**
 Polyamide 6 – **RANE**
Heavy Series
Order codes for clamp-halves:

 Polypropylene – **RCPE**
 Polyamide 6 – **RCNE**
Elastomer Inlay
Order code: EE-*

* complete with clamp size and outside tube diameter

Clamp size		Tube O.D. mm	Series A		Series C		Elastomer inlay
Serie A	Serie C		Clamp body	Clamp body with elastomer inlay	Clamp body	Clamp body with elastomer inlay	
4	2	6.0	RAPE4X	RAPE406X	RCPE2X	RCPE206X	EE206/406X
		8.0		RAPE408X		RCPE208X	EE208/408X
		10.0		RAPE410X		RCPE210X	EE210/410X
		12.0		RAPE412X		RCPE212X	EE212/412X
		12.7		RAPE412.7X		RCPE212.7X	EE212.7/412.7X
		14.0		RAPE414X		RCPE214X	EE214/414X
		15.0		RAPE415X		RCPE215X	EE215/415X
		16.0		RAPE416X		RCPE216X	EE216/416X
		17.2		RAPE417.2X		RCPE217.2X	EE217.2/417.2X
		18.0		RAPE418X		RCPE218X	EE218/418X
		19.0		RAPE419X		RCPE219X	EE219/419X
6	3	20.0	RAPE6X	RAPE620X	RCPE3X	RCPE320X	EE320/620X
		21.3		RAPE621.3X		RCPE321.3X	EE321.3/621.3X
		22.0		RAPE622X		RCPE322X	EE322/622X
		23.0		RAPE623X		RCPE323X	EE323/623X
		25.0		RAPE625X		RCPE325X	EE325/625X
		26.9		RAPE626.9X		RCPE326.9X	EE326.9/626.9X
		28.0		RAPE628X		RCPE328X	EE328/628X
		30.0		RAPE630X		RCPE330X	EE330/630X
		32.0		RAPE632X		RCPE332X	EE332/632X
				4		32.0	
33.7	RCPE433.7X		EE433.7X				
35.0	RCPE435X		EE435X				
38.0	RCPE438X		EE438X				
40.0	RCPE440X		EE440X				
42.0	RCPE442X		EE442X				
45.5	RCPE445.5X		EE445.5X				
48.0	RCPE448X		EE448X				
51.0	RCPE451X		EE451X				
53.4	RCPE453.4		EE453.4X				
56.4	RCPE456.4X		EE456.4X				

Attention! For clamps with elastomer inlay, the relation of diameter and size is not identical with the profile design or smooth design.

Tube clamps series 2+5 (Light construction series)

DIN 3015, Part 1, Components

Order codes
for clamp-halves:

 Polypropylen **RAP**
 inside smooth **RAPG**

 Polyamid 6 **RAN**
 inside smooth **RANG**

 Rubber **RAVG**

Replace standard abbreviation RAP in column "clamp halves" as required.



Size 2

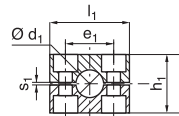

Size 2

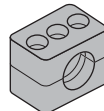

Size 5

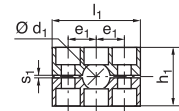

Size 5

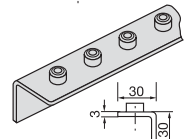
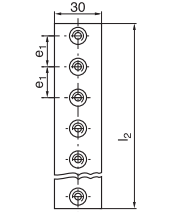
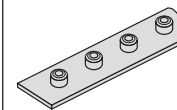
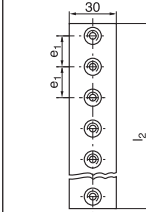

Clamp size	O.D. mm	Tube NB	Inch O.D.	1 part	2 clamp-halves	Multiple	Multiple		
				2 clamp-halves	Multiple	Multiple			
	d_1			RAP	RAP-...	APRLA2X	APRWLA2X		
				Order code	l_1 h_1 e_1 s_1	e_1 l_2	e_1 l_2		
2	6.0	G 1/8	1/4	RAP206X	40 33 26 0.8	26 508	26 508		
	6.4			RAP206.4X					
	8.0			RAP208X					
	9.5		RAP209.5X						
	10.0		RAP210X						
	12.0	G 1/4	3/8	RAP212X					
	12.7			RAP212.7X					
	13.5		RAP213.5X						
	14.0		RAP214X						
	15.0		RAP215X						
16.0	G 3/8	5/8	RAP216X						
17.2			RAP217.2X						
18.0			RAP218X						
5			19.0	G 1/2	3/4	RAP519X	70 58 26 1.2	26 508	26 508
			20.0			RAP520X			
	21.3	RAP521.3X							
	22.0	RAP522X							
	23.0	G 3/4	1	RAP523X					
	25.0			RAP525X					
	26.9			RAP526.9X					
	28.0			RAP528X					
	30.0	G 1	1 1/4	RAP530X					
	32.0			RAP532X					
	33.7			RAP533.7X					
	35.0			RAP535X					
	38.0	G 1 1/4	1 1/2	RAP538X					
	40.0			RAP540X					
42.0	RAP542X								

 When assembling solid rubber clamps, cover plates, hexagon screws and locking washers must be used.
 All metal parts available in stainless steel.

Tube clamps series 2+5 (Light construction series)

DIN 3015, Part 1, Components

Cover plate		Bolts		Bolts		Bolts		Locking washer ¹⁾	
DPA	DPA l ₃ 3 ₁	Slot head SLA	Slot head SLA d x L	Socket head ISA	Socket head ISA d x L	Hexagon head SSLA	Hexagon head SSLA d x L	USA/USB1X a	b
DPA2X	40 26	SLA2X	M 06x25	ISA2X	M 06x25	SSLA2/ SSB1X	M 06x25	9	18
DPA5X	70 52	SLA5X	M 06x50	ISA5X	M 06x50	SSLA5X	M 06x60		

1) When assembling solid rubber clamps, cover plates, hexagon screws and locking washers must be used.

Tube clamps series 2+5 (Light construction series)

DIN 3015, Part 1, Components

Bolts		Locking plate ²⁾		Welding plate, short		Mounting rail	Mounting rail	Rail nut				
Stacking ²⁾ ASA	Stacking ²⁾ ASA l ₅	SBAX a SW		APKA	APKA e ₁ L ₂	TS-A/B	TS-AB l h ₂	TMA/TMB1 a b c d ₆				
ASA2X	25	30	11	APKA2X	26 42	TS11A/B1X TS11A/B2X TS14A/b1X TS14A/b2X TS30A/b1X TS30A7b2X	1 m 11 2 m 11 1 m 14 2 m 14	TMA/TMB1 VERZX	25.4	10.4	12	M6
ASA5X	50			APKA5X	52 72		1 m 30 2 m 30					

²⁾ The usage of stacking bolts necessitates the use of locking plates during the construction assembly.

The fully flexible tube clamp.

Optimum insulation against noise and vibration.

The Primary Material

The fully flexible tube clamps are made out of thermoplastic caoutchouc.

The advantages

Excellent noise insulation and vibration properties. Easy securing also of sensitive tube and pipe installations.

The material properties are appreciably higher than those of comparable vulcanized rubber products.

The Construction Details

The internal surfaces are smooth or grooved. A useful screw safety-device guarantees perfect connections and together with the solid rubber construction eliminates self loosening!

The welding plates, covers and screws are also available in stainless steel.

Low noise and vibration level

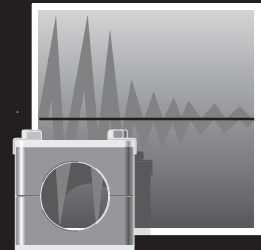

Weather-proof and brittle-resistant



Shape stability with high elasticity



Resistant against many chemicals



Wide temperature applications

